

Manual

Yealink T33G IP Phone

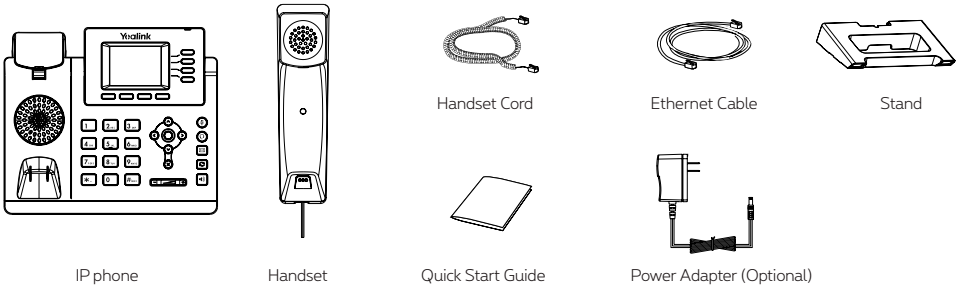

Package Contents



We recommend that you use the accessories provided or approved by Yealink. The unapproved third-party accessories may result in reduced performance.

Attach the stand

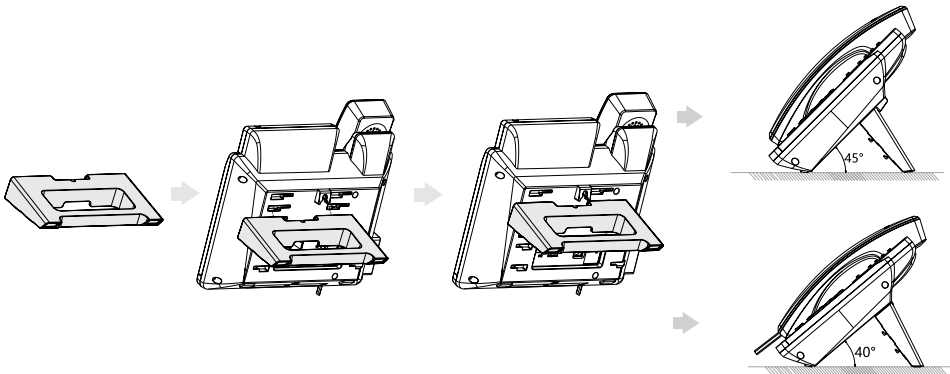

You can also mount the phone to a wall.

Placing a Call

Using the handset:

1. Pick up the handset.
2. Enter the number and press the **Send** soft key.

Using the speakerphone:

1. With the handset on-hook, press .
2. Enter the number and press the **Send** soft key.

Using the headset:

1. With the headset connected, press  to activate the headset mode.
2. Enter the number and press the **Send** soft key.

Answering a Call

Using the handset: pick up the handset.

Using the speakerphone: press .

Using the headset: press .

You can reject an incoming call by pressing the **Reject** soft key.



Ending a Call

Using the handset: hang up the handset or press the **EndCall** soft key.



Using the speakerphone: press  or the **EndCall** soft key.

Using the headset: press the **EndCall** soft key.

Redial

- Press  to enter the Placed Calls list, select the desired entry, and press or the **Send** soft key.
- Press  twice when the phone is idle to dial out the last dialed number.

Call Mute

- Press  to mute the microphone during a call.
- Press  again to un-mute the call.

Call Hold

To place a call on hold:

Press the **Hold** soft key during an active call.

To resume the call, do one of the following:

- If there is only one call on hold, press the **Resume** soft key.
- If there is more than one call on hold, select the desired call, and press the **Resume** soft key.

Call Transfer

You can transfer a call in the following ways:

Blind Transfer

1. Press the **Trans** soft key during an active call.
2. Enter the number you want to transfer to.
3. Press the **B Trans** soft key.

Semi-Attended Transfer

1. Press the **Trans** soft key during an active call.
2. Enter the number you want to transfer to, and press the **Send** soft key.
3. Press the **Trans** soft key when you hear the ring-back tone.

Attended Transfer

1. Press the **Trans** soft key during an active call.
2. Enter the number you want to transfer to, and press the **Send** soft key.
3. Press the **Trans** soft key when the second party answers.

Call Forward

To enable call forward:

1. Press the **Menu** soft key when the phone is idle, and then select **Features ▶ Call Forward**.
2. Select the desired forward type.
3. Enter the number you want to forward to. For **No Answer Forward**, select the desired ring time to wait before forwarding from the **After Ring Time** field.
4. Press the **Save** soft key to accept the change.

Call Conference

1. Press the **Conf** soft key during an active call. The call is placed on hold.
2. Enter the number of the second party, and press the **Send** soft key.
3. Press the **Conf** soft key again when the second party answers. All parties are now joined in the conference.
4. Press the **EndCall** soft key to disconnect all parties.

You can split the conference call into two individual calls by pressing the **Split** soft key.

Speed Dial

To configure a speed dial key:

1. Press the **Menu** soft key when the phone is idle, and then select **Features ▶ DSS keys**.
2. Select the desired DSS key, and press the **Enter** soft key.
3. Select **SpeedDial** from the **Type** field, select the desired line from the **Account ID** field, enter a label in the **Label** field, enter the number in the **Value** field.
4. Press the **Save** soft key to accept the change.

To use the speed dial key:

Press the speed dial key to dial out the preset number.



Voice Message

Message waiting indicator on the idle screen indicates that one or more voice messages are waiting at the message center. The power indicator LED slowly flashes red.

To listen to voice messages:

1. Press  or the **Connect** soft key.
2. Follow the voice prompts to listen to your voice messages.

Call History

1. Press the **History** soft key when the phone is idle, press  or  to scroll through the list.
2. Select an entry from the list, you can do the following :
 - Press the **Send** soft key to call the entry.
 - Press the **Delete** soft key to delete the entry from the list.

If you press the **Option** soft key, you can also do the following :



- Select **Detail** to view detailed information about the entry.
- Select **Add to Contacts** to add the entry to the local directory..
- Select **Add to Blacklist** to add the entry to the blacklist.
- Select **Delete All** to delete all entries from the list.

Contact Directory



To add a contact:

1. Press the **Dir** soft key when the phone is idle, and then select **All Contacts**.
2. Press the **Add** soft key to add a contact.
3. Enter a unique contact name in the **Name** field and contact numbers in the corresponding fields.
4. Press the **Save** soft key to accept the change.

To edit a contact:

1. Press the **Dir** soft key when the phone is idle, and then select **All Contacts**.
2. Press  or  to select the desired contact, press the **Option** soft key and then select **Detail** from the prompt list.
3. Edit the contact information.
4. Press the **Save** soft key to accept the change.

To delete a contact:

1. Press the **Dir** soft key when the phone is idle, and then select **All Contacts**.
2. Press  or  to select the desired contact, press the **Option** soft key and then select **Delete** from the prompt list.
3. Press the **OK** soft key when the LCD screen prompts « Delete selected item ».

Volume Adjustment

Press  to adjust the volume.

Regulatory Notices

Operating Ambient Temperatures

- Operating temperature: +14 to 122°F (-10 to 50°C)
- Relative humidity: 5% to 90%, noncondensing
- Storage temperature: -22 to +160°F (-30 to +70°C)

Warranty

Our product warranty is limited only to the unit itself, when used normally in accordance with the operating instructions and the system environment. We are not liable for damage or loss resulting from the use of this product, or for any claim from a third party. We are not liable for problems with Yealink device arising from the use of this product; we are not liable for financial damages, lost profits, claims from third parties, etc., arising from the use of this product.

DC symbol

 is the DC voltage symbol.

Restriction of Hazardous Substances Directive (RoHS)

This device complies with the requirements of the EU RoHS Directive. Statements of compliance can be obtained by contacting support@yealink.com.

Safety Instructions

Save these instructions. Read these safety instructions before use!

The following basic safety precautions should always be followed to reduce risk of fire, electrical shock, and other personal injury.

General Requirements

- Before you install and use the device, read the safety instructions carefully and observe the situation during operation.
- During the process of storage, transportation, and operation, please always keep the device dry and clean.
- During the process of storage, transportation, and operation, please avoid collision and crash of the device.
- Please attempt not to dismantle the device by yourself. In case of any discrepancy, please contact the appointed maintenance center for repair.
- Without prior written consent, no organization or individual is permitted to make any change to the structure or the safety design of the device. Yealink is under no circumstance liable to consequences or legal issues caused by such changes.
- Please refer to the relevant laws and statutes while using the device. Legal rights of others should be respected as well.

Environmental Requirements

- Place the device at a well-ventilated place. Do not expose the device under direct sunlight.
- Keep the device dry and free of dusts.
- Place the device on a stable and level platform.
- Please place no heavy objects on the device in case of damage and deformation caused by the heavy load.
- Keep at least 10 cm between the device and the closest object for heat dissipation.
- Do not place the device on or near any inflammable or fire-vulnerable object, such as rubber-made materials.
- Keep the device away from any heat source or bare fire, such as a candle or an electric heater.
- Keep the device away from any household appliance with strong magnetic field or electromagnetic field, such as a microwave oven or a refrigerator.

Operating Requirements

- Do not let a child operate the device without guidance.
- Do not let a child play with the device or any accessory in case of accidental swallowing.
- Please use the accessories provided or authorized by the manufacturer only.
- The power supply of the device shall meet the requirements of the input voltage of the device. Please use the provided surge protection power socket only.
- Before plugging or unplugging any cable, make sure that your hands are completely dry.
- Do not spill liquid of any kind on the product or use the equipment near water, for example, near a bathtub, washbowl, kitchen sink, wet

- Do not tread on, pull, or over-bend any cable in case of malfunction of the device.
- During a thunderstorm, stop using the device and disconnect it from the power supply. Unplug the power plug and the Asymmetric Digital Subscriber Line (ADSL) twisted pair (the radio frequency cable) to avoid lightning strike.
- If the device is left unused for a rather long time, disconnect it from the power supply and unplug the power plug.
- When there is smoke emitted from the device, or some abnormal noise or smell, disconnect the device from the power supply, and unplug the power plug immediately. Contact the specified maintenance center for repair.
- Do not insert any object into equipment slots that is not part of the product or auxiliary product.
- Before connecting a cable, connect the grounding cable of the device first. Do not disconnect the grounding cable until you disconnect all other cables.

Cleaning Requirements

- Before cleaning the device, stop using it and disconnect it from the power supply.
- Use a piece of soft, dry and anti-static cloth to clean the device.
- Keep the power plug clean and dry. Using a dirty or wet power plug may lead to electric shock or other perils.

ENVIRONMENTAL RECYCLING



Never dispose of the device with domestic waste

Ask your Town Council about how to dispose of it in an environmentally friendly way. The cardboard box, plastic packaging and player components may be recycled in accordance with prevailing recycling regulations in your country.

Always adhere to prevailing regulations

Those who fail to do so may be fined or prosecuted in accordance with the law. The crossed out garbage can that appears on the device means that when it has reached the end of its useful life, it should be taken to a special waste disposal centre and treated separately to general urban waste.

Troubleshooting

The unit cannot supply power to Yealink device.

There is a bad connection with the plug.

1. Clean the plug with a dry cloth.

2. Connect it to another wall outlet.

The usage environment is out of operating temperature range.

1. Use in the operating temperature range.

The cable between the unit and the Yealink device is connected incorrectly.

1. Connect the cable correctly.

You cannot connect the cable properly.

1. You may have connected a wrong Yealink device.

2. Use the correct power supply.

Some dust, etc., may be in the port.

1. Clean the port.

Contact your dealer or authorized service facility for any further questions.

Contact Information

YEALINK NETWORK TECHNOLOGY CO.,LTD.

309, 3rd Floor, No.16, Yun Ding North Road, Huli District, Xiamen City, Fujian, P.R.C

YEALINK (EUROPE) NETWORK TECHNOLOGY B.V.

Strawinskylaan 3127, Atrium Building, 8th floor, 1077ZX Amsterdam, The Netherlands

YEALINK (USA) NETWORK TECHNOLOGY CO., LTD.

999 Peachtree Street Suite 2300, Fulton, Atlanta, GA, 30309, USA

Made in China



Declaration of Conformity

We,
YEALINK(XIAMEN) NETWORK TECHNOLOGY CO.,LTD,
Address: 309, 3rd Floor, No.16, Yun Ding North Road,
Huli District, Xiamen City, Fujian, P.R.C

CE DATE: 10th /July/2020

declare that the product

Type: Classic IP Phone

Model: SIP-T33P, SIP-T33G

meets the essential requirements and other relevant provisions according to the following EC directive

**Directive: 2014/35/EU, 2014/30/EU;
Conformity**

The product complies with the following standards:

Safety : **EN 62368-1:2020/A11:2020**

EMC: **EN 55032:2015**

EN 55035:2017

EN61000-3-2: 2014

EN61000-3-3: 2013

Directive 2011/65/EU and (EU)2015/863 of the European Parliament and of the Council of 8 June 2011 and 4 June 2015 on the restriction of the use of certain hazardous substances in electrical and electronic equipment(RoHS 2.0)

Directive 2012/19/EU of the European Parliament and of the Council of 4.July.2012 on Waste electrical and electronic equipment(WEEE)

Regulation (EC) No.1907/2006 of the European Parliament and of the Council of 18.December.2006 on Registration, Evaluation, Authorization, and Restriction of Chemicals (REACH)

NAME: Stone Lu

DATE: 10/July/2020

TITLE: Vice President

YEALINK (EUROPE) NETWORK TECHNOLOGY B.V
Address: Strawinskyiaan 3127, Atrium Building, 8th floor,
1077ZX Amsterdam, the Netherlands
Telephone: +31(0)646111373
Email: EUROPE@Yealink.com



Addr: 309, 3rd Floor, No.16, Yun Ding North Road,
Huli District, Xiamen City, Fujian, P.R.C

Tel: +86-592-5702000
Fax: +86-592-5702455

About Yealink

Yealink (Stock Code: 300628) is a global brand that specializes in video conferencing, voice communications and collaboration solutions with best-in-class quality, innovative technology and user-friendly experience. As one of the best providers in more than 140 countries and regions, Yealink ranks No.1 in the global market share of SIP phone shipments (Global IP Desktop Phone Growth Excellence Leadership Award Report, Frost & Sullivan, 2019).

Technical Support

Visit Yealink WIKI (<http://support.yealink.com/>) for the latest firmware, guides, FAQ, Product documents, and more. For better service, we sincerely recommend you to use Yealink Ticketing system (<https://ticket.yealink.com>) to submit all your technical issues.

YEALINK(XIAMEN) NETWORK TECHNOLOGY CO.,LTD.
Web: www.yealink.com
Copyright©2020 YEALINK(XIAMEN) NETWORK
TECHNOLOGY CO.,LTD.All rights reserved.