

# MAESTRO 2055

## Introduction

Belgacom thanks you for choosing the Maestro 2055, a telephone for both the home and the office, which offers many advanced services such as :

- Incoming call numbers display and the storage of these numbers, times and dates of calls.
- SMS sending, receiving and storing

---

## EU Statement of Compliance

Industrie Dial Face S.p.A., based at 4 Via Canzo 20068 - Peschiera Borromeo (MI) Italy, declares under its own responsibility that the Maestro 2035 telephone equipment complies with the following stan-dards: EN 55024, EN 55022 – Electro-magnetic compatibility

EN 60950 – Electrical Safety

and meets the requirements of Directive 1999/5/CE of the European Parliament and Council dated 9 March 1999 in relation to radio equipment and telecommunication terminals and the recognition of reciprocal compliance.

**Compliance with these provisions is demonstrated by the mark **

---

## Use of the telephone

The telephone has been designed for connection to Belgacom analogue telephone network.

---

## Important advice

Do not use the telephone in an environment which is excessively humid, dusty, gas saturated or with risk of water contact. In addition, do not expose it to direct sunlight or other sources of heat. It is advised not to place the device on slippery or delicate surfaces but to install it at a distance of at least one meter from other devices that are the source of parasites such as cordless equipment, beepers, televisions and industrial machinery, etc. Clean it by using a damp cloth or antistatic wipe. Do not use dry cloths or corrosive cleaners.

Where the device remains unplugged from the network in order to preserve it, it is advisable to remove the batteries from their housing to avoid any damage by contacts due to the leakage of the liquid they contain.

Each of these conditions can affect the operating and appearance of the product over time.

**For safety reasons, always unplug the network cable before removing the batteries, when replacing them and also during telephone maintenance.**

Keep this user manual safe and observe environmental standards when discarding the equipment.

<b>INTRODUCTION</b>	1
EU Statement of Compliance	1
Use of the telephone	1
Important Advice	1
<b>SUMMARY</b>	2
<b>1 INSTALLATION AND START-UP</b>	
1.1 Description of the telephone	4
1.2 Display symbols	4
1.3 Content of the box	5
1.4 Installing the telephone	6
1.5 Wall intallation	6
1.6 Telephone start-up	6
1.7 Replacing the batteries	7
1.8 Delivery configuration	7
1.9 Technical and functional features	8
<b>2 CUSTOMISATION / PROGRAMMING</b>	
Menu	9
2.1 Setting the language	10
2.2 Setting the light on the display	10
2.3 Serring time and date	11
2.4 Setting the ringer	11
2.4.1 Setting the ringer melody	11
2.4.2 Setting the ringer volum level	12
2.4.3 Setting the ring mode	12
2.4.4 VIP filter	13
2.4.5 "No ringer anonymous" filter	13
2.4.6 "Black list" filter	13
2.5 Setting the "Fast call"	14
2.6 Setting "Direct call"	16
2.7 Setting PABX prefix	16
2.8 Setting PABX pause	17
2.9 Setting Flash time	17
2.10 Setting CLI on CW	17
2.11 Setting the keypad lock PIN	18
2.12 Reset code	18
<b>3 USE OF THE TELEPHONE</b>	
3.1 Connecting and disconnecting from the telephone network	19
3.2 Hands-free mode	19
3.3 Answering to an incoming call	19
3.4 Making a call	20
3.4.1 Normal call	20
3.4.2 Call with pre-selection	20
3.4.3 Calling a last number dialled	20
3.5 The Phonebook	21
3.5.1 Storing in the Phonebook	22
3.5.2 Show numbers of the Phonebook	22
3.5.3 Modify numbers of the Phonebook	23
3.5.4 Modify names of the Phonebook	25
3.5.5 Modify a Ring melody associated to a name of the Phonebook	25
3.5.6 Ring filter	26
3.5.7 Erase a name of the Phonebook	26
3.5.8 VIP list	27
3.5.9 Black list	27
3.5.10 Free memory	28
3.5.11 Storing a number of the CLI list in the Phonebook	28

3.5.12	Storing a number of the LN dialled list in the Phonebook.....	29
3.6	Dialling numbers of the Phonebook / VIP / Fast call .....	30
3.7	Caller identification .....	31
3.7.1	Call a number of the "Received" call list.....	32
3.7.2	Erase numbers of the "Received" call list.....	32
3.8	2nd Call handling .....	33
3.9	Mute the Microphone.....	33
3.10	Loudspeaker volume adjusting .....	34
3.11	Group listening mode.....	34
3.12	Keyboard lock.....	34
3.13	Reminders (alarms) .....	34
3.14	Phone info .....	38
<b>4</b>	<b>NETWORK SERVICES</b>	
4.	Use of Network services .....	39
4.1	Call forwarding.....	39
4.1.1	Call forwarding unconditional .....	39
4.1.2	Call forwarding if not reply.....	40
4.1.3	Call forwarding when busy.....	41
4.2	Fixed destination call .....	42
4.3	Call waiting (2nd call) .....	43
4.4	Ring back .....	44
4.5	PhoneMail and services .....	45
<b>5</b>	<b>ADDITIONAL OPTIONS</b>	
5.1	Options available in idle mode .....	47
5.1.1	Save a displayed number.....	47
5.1.2	Introducing a pause .....	48
5.1.3	Make a call as visible.....	48
5.1.4	Make a call as anonymous.....	48
5.2	Options in conversation mode .....	49
5.2.1	Activate call-back.....	49
5.2.2	Start 2nd call .....	49
5.2.3	Accept 2nd call.....	49
5.2.4	Alternate .....	49
5.2.5	Conference call.....	50
5.2.6	Call transfer.....	50
5.2.7	Reject 2nd call .....	50
5.2.8	Terminate call .....	50
<b>6</b>	<b>USE OF SMS SERVICE</b>	
6.1	Configuring the SMS service .....	51
6.1.1	Modify the SMS center numbers .....	51
6.1.2	Assign a name to a SMS Box.....	52
6.1.3	Assign a number to a SMS Box.....	52
6.1.4	Assign a PIN code to a SMS Box.....	53
6.1.5	Activate / Deactivate EATONI function.....	53
6.1.6	Deactivate a SMS Box.....	53
6.1.7	Activate a SMS Box.....	54
6.2	SMS Sending .....	54
6.2.1	Reading and Options of the SMS sent.....	55
6.3	SMS Receiving .....	56
6.3.1	Reading received SMS .....	56
6.3.2	Options menu "Read received" .....	57
6.4	EATONI (SMS only) .....	57
	Warranty .....	59

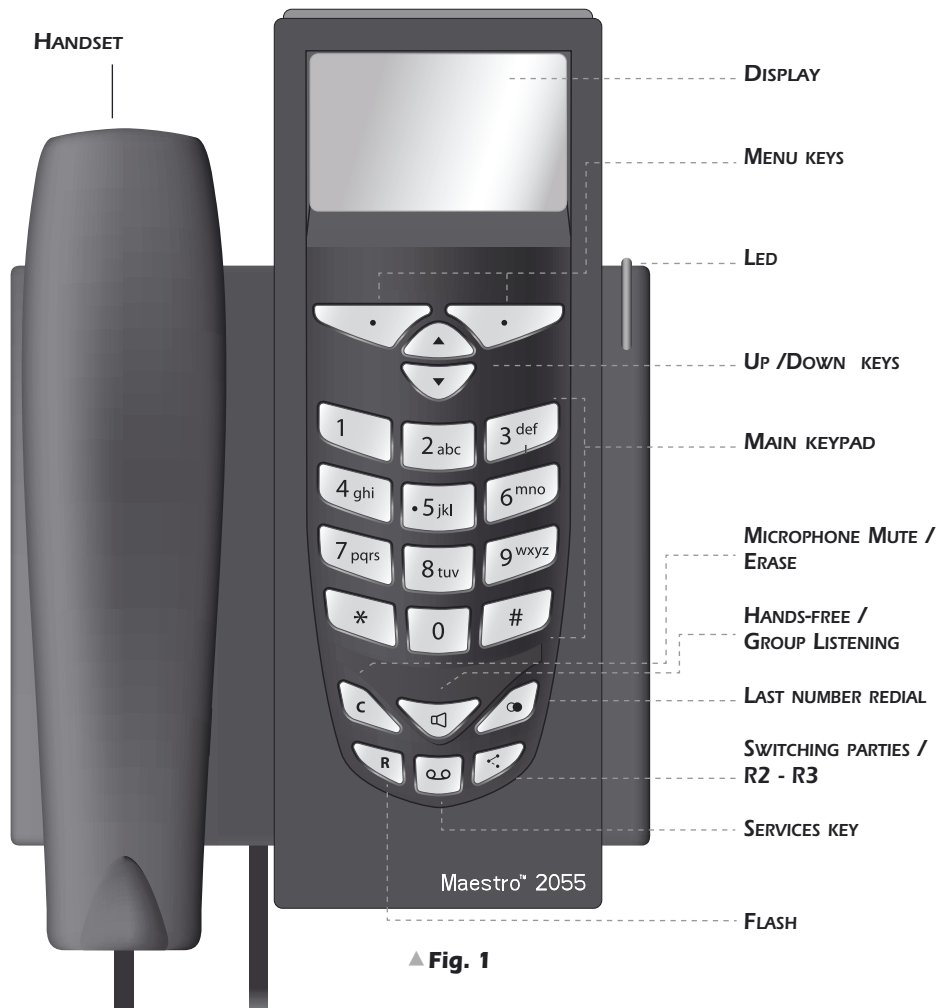
**1.1 Description of the telephone**

▲ Fig. 1

**1.2 Display symbols**











- |  |   |
|--|---|
|  <b>A/B/C</b> New SMS received in box A/B/C          |  Ringer deactivated, Filtre VIP, Black list, hidden number, ring delayed |
|  <b>A/B/C</b> SMS Memory messages full for box A/B/C |  Alarm On  |
|  New not answered incoming calls                     |  Alarm not stopped   |
|  Hands-free/Group-listening                          |  PhoneMail   |
|  Batteries off                                       |  Direct call activated   |

Fig. 2 ▶



## 1.3 Content of the box

1 handset	1 line cord	1 line plug in	1 user manual
1 spiral cord	1 base	1 AC/DC supplier	(with guarantee card)

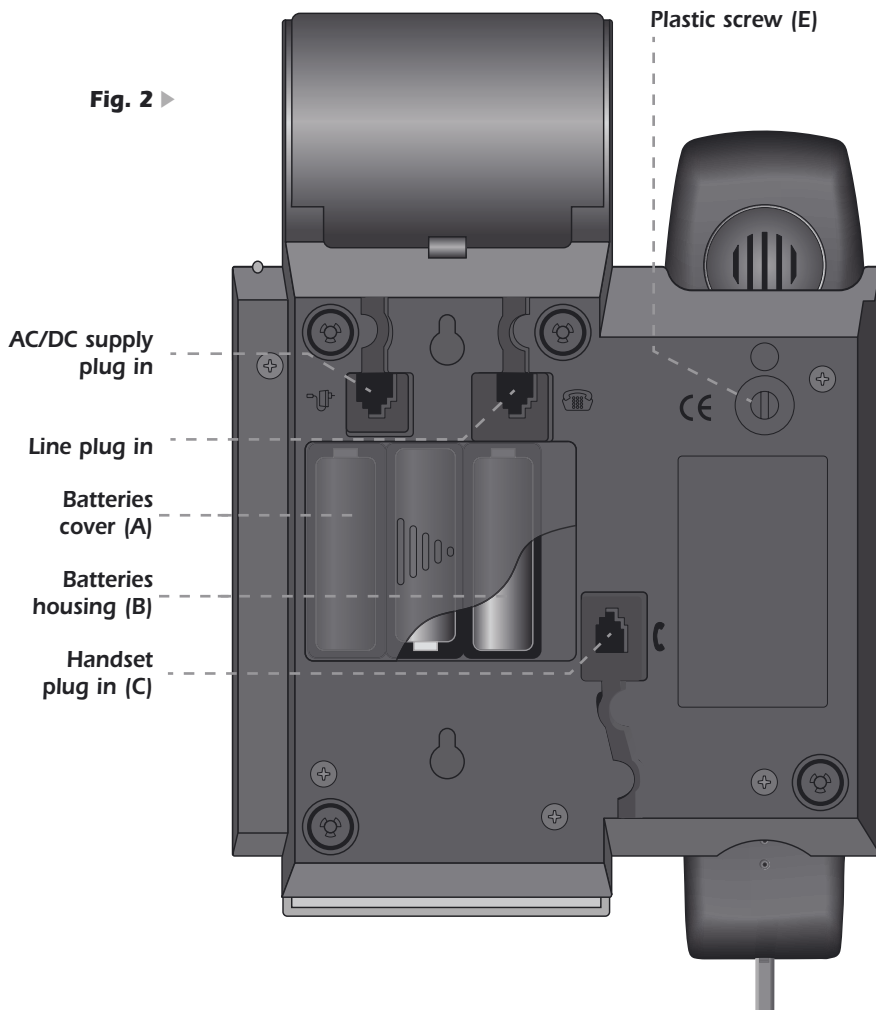
All the functions are available if the telephone is supplied via AC/DC supplier and/or via 3 batteries 1.5Vdc size AA. Batteries are not provided with the telephone.

## **1.4 Installing the telephone**

Proceed as follows :

- 1) Put the shortest end of the spiral cable into the handset connector and put the other end into the small socket (C) located at the bottom of the telephone base (identified by an handset (fig.2). Place the flat part of the cord into the groove located at the bottom of the base.
- 2) Put one end of the line cord into the socket located at the bottom of the base (fig2). Place the flat part of the cord into the groove located at the bottom of the base.
- 3) Insert the four-poles plug into the telephone socket.
- 4) Insert the AC/DC supplier plug into the connector located at the bottom of the base (supplier symbol). Insert the 230Vac plug of the supplier into the 230Vac socket.

NB - To install the batteries (fig.2) remove the cover (A) located at the bottom of the base, insert the batteries in accordance with the polarities indicated into the batteries housing (B) and close the cover.

N.B. Batteries or AC/DC supplier or both may be used.

**Important:** before to take the cover out, the line cord MUST NOT be connected to the Maestro 2055.

**After this operation, the Maestro 2055 installation is finished.**

---

## **1.5 Wall installation**

The Maestro 2055 can be fixed to the wall. Before fixing it, assembly the different parts and proceed as follows:

- 1) Drill two holes of 5mm diameter at a distance of 100 mm.
- 2) Insert the wall plugs into the holes and screw the screws until they are at 5 mm distance from the wall.
- 3) Turn the plastic pivot pin (posit. E on the bottom of the base) 180° on the right side. Stick the telephone to the wall so that the screw heads fully penetrate the large buttonhole. Then block the subset by pulling it in a downward direction.
- 4) If not yet done, plug the four-pole plug into the telephone socket.

---

## **1.6 Telephone start-up**

To start the telephone, after completing its installation in accordance with the instructions, check that the telephone line is connected to the socket, lift the handset up, ensure there is a tone and then hang up. This operation confirms the equipment has been correctly installed and it is then possible to proceed with the operations explained in the following paragraphs.

## 1.7 Replacing the batteries

When the batteries are discharged or taken out and if the AC/DC supplier is not used, the telephone provides all the basic functions. It is necessary to replace the batteries if the display shows  when the handset is picked up.

To replace the batteries, refer to fig.2 and proceed as follows:

- 1) Unplug the line cord by removing the connector from its socket. In order to remove the connector correctly, press the safety pin towards the cord and pull without forcing it.
- 2) Remove the battery cover
- 3) Replace the batteries, paying attention to the polarity
- 4) Close the cover
- 5) Plug the line back in by putting the connector fully back into its socket (until it clicks).

**N.B.** For safety reasons, follow the information set out in the paragraph entitled "Important Advice". Discharged batteries are not rechargeable and should be disposed of using containers provided for this purpose in full compliance with current environmental standards.

**WARNING : DO NOT CONNECT THE TELEPHONE TO THE TELEPHONE NETWORK WITHOUT FIRST REPLACING THE BATTERY COVER.**

---

## 1.8 Delivery configuration

Ringer volume . . . . .	3
Ringer melody . . . . .	1
Loudspeaker volume . . . . .	level 4
Date and time . . . . .	01 Jan 05 00:00
Alarm . . . . .	Deactivated
VIP filter . . . . .	Deactivated
1st Ring deactivation . . . . .	Yes
No ring anonym. . . . .	Deactivated
Black Liste . . . . .	Deactivated
Language . . . . .	English
PIN Code box SMS . . . . .	No
PABX Prefix . . . . .	No
Pause . . . . .	1 second
Service center 1 (send). . . . .	1717
Service center 2 (receive) . . . . .	01717
SMS Function . . . . .	Activated
Dialling mode . . . . .	DTMF

## **1.9 Technical and functional features**

- 22 keys keyboard : 12 alphanumeric keys + 4 navigation menu keys + 6 function keys
- Graphic LC display, 102 x 64 pixels, 6 lines /16 alphanumeric characters each, backlight
- Pre-selection
- Flash : 125 +/- 5 ms
- Hands-free
- Group listening
- 4 levels loudspeaker volume adjusting
- 15 melodies (3 normal + 12 polyphonic )
- Adjustable ringer volume (3 levels + not activated)
- Led to indicate incoming call and line engaged
- Mute microphone

### Phonebook

- 250 name-number (20 characters by name - 26 characters by memory number)
- Classification (type) of the numbers (Internal / External / VIP / Black)
- Icons (Generic - Mobile - Home - Office) of the type of number
- Ringer activation for pre-defined numbers (VIP list, ring filter)
- Ringer melodies associated to a stored name - number
- Fast dialling (10 numbers max)
- Direct key to access a 30 last numbers dialled list (32 digits each number)

### Caller number / name identification and presentation (CLIP/CNIP : if services available on the line)

- Display the callers name / number de l'appelant (also for a 2nd incoming call when in conversation)
- 50 elements CLIP/CNIP list ( name-number -date-hour)
- Dialling an element of the CLIP/CNIP list

### Network Services

- "Network services" handled via menu
- Dedicated key for the 2nd call function
- Reminders/Clock/Conversation elapsing time
- PABX prefix programmability (1 number, 4 digits max.)
- Automatic pause insertion after PABX prefix dialling (1,2,3,4 secondes)

### SMS sending and receiving

- SMS sending and receiving (160 characters max. each message)
- PIN Code for each Box SMS
- 3 Box SMS max. availability by program
- 80 messages per Box SMS max. / 20 messages of 160 characters per Box SMS
- SMS Centers numbers programmability
- Eatoni (predictive mode of writing SMS)
- 4 languages (FR/NL/D/UK)
- Wall mounting
- Supply via AC/DC (230Vac main) supplier or by 3 batteries 1,5 V / type AA (not included).



# 2 CUSTOMISATION PROGRAMMING

Personalization can be done when the telephone is supplied via main or via batteries or both cases.

## Menu







Menu

Main menu

Messages	A: Box A  B: Box B C: Box C Service center	Write new Read received Read written Erase messages Settings Availanle memory  Service center 1 Service center 2
Call list	Received Placed Erase all	Received Placed
Network services	Call forwarding Fixed dest. call Call waiting Deact. ring back	All calls/ If not answered/ When busy Activation / Deactivation Activation / Deactivation
Reminders	List New  Erase all	Single, Yearly, Monthly, Weekly, Daily, Hourly
Settings	Display Ring Clock Fast call Direct call PABX prefix PABX pause Flash CLI on CW Language Lock PIN Reset code	
Keyboard lock	---	
Phone info	SMS subaddresses Ring settings Direct call SW release	

## **2.1 Setting the language**





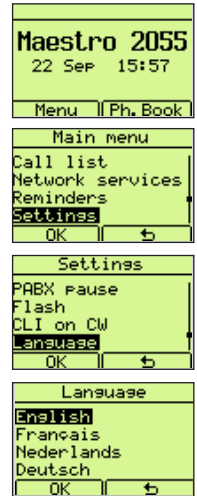





Four languages are available : English, Français, Nederlands, Deutsch. To select a language, proceed as follows:

- Press **[Menu]** key to enter in the main menu .
- Scroll the menu items via   keys to select "Settings" and press **[OK]** to confirm.
- Press   keys to select "Language" and press **[OK]** key to confirm.
- Select the desired language via  , then press **[OK]** to confirm.
- Press **[↵]** to exit the menu and to go back to idle.



## **2.2 Setting the light on the display**



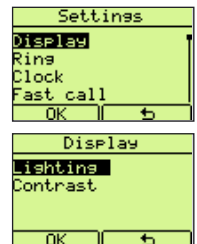

The user can choose between 3 lighting modes (Normal, Always off, Always on) and 12 levels of contrast. Proceed as follows:

- Press **[Menu]** key to enter in the main menu .
- Scroll the menu items via   keys to select "Settings" and press **[OK]** to confirm.
- Press   keys to select "Display" and press **[OK]** key to confirm.
- Select "Lighting" or "Contrast" via   keys, then press **[OK]** key to confirm
- If "Lighting" has been chosen, select Normal/ Always off/ Always on via   keys and press **[OK]** to pour confirm.  
**Note:** the option "Always on" cannot be activated if the Maestro 2055 is supplied via AC/DC supplier.
- If "Contrast", select the desired level (de 1 à 12) via   keys and press **[OK]** key to confirm.
- It is possible to get back by pressing **[↵]** key.



## 2.3 Setting time and date

Proceed as follows:

- Press **[Menu]** key to enter in the main menu .
- Scroll the menu items via   keys to select "Settings" and press **[OK]** to confirm.
- Press   keys to select "Clock" and press **[OK]** key to confirm.
- Enter the day via numeric keys (01-31).
- Enter the month 01 - 12).
- Enter the year (00 - 99).
- Enter the hour (00 - 23).
- Enter the minutes (00-59).
- Press **[OK]** key to confirm.

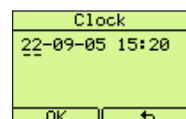
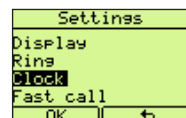

The display will show time and date (jj-mm hh-mm) when the telephone is in idle. The clock is updated at each incoming call (if CLI/CNIP service is available and has been subscribed).



If the entered data are wrong, a message of error will be displayed after the confirmation.

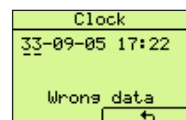





## 2.4 Setting the ringer





It is possible to choose the melody, the ringer level volume and how the ringer will react when a call comes.

### 2.4.1 Setting the ringer melody

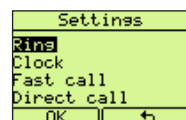
It is possible to choose between 15 melodies (3 normal + 12 polyphonic) as follows:

- Press **[Menu]** key to enter in the main menu .
- Scroll the menu items via   keys to select "Settings" and press **[OK]** to confirm.
- Press   keys to select "Ring" and press **[OK]** key to confirm.





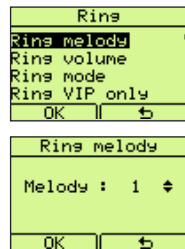





- Press   keys to select "Ring melody". Then press **[OK]** key to confirm.
- Press   keys pour to select the desired melody (de 1 à 15 ), then press **[OK]** key to confirm.



### 2.4.2 Setting the ringer volume level

It is possible to choose the level of the ringer volume between 3 different levels: minimum (1), medium (2), maximum (3). Proceed as follows:

- Press **[Menu]** key to enter in the main menu .
- Scroll the menu items via   keys to select "Settings" and press **[OK]** to confirm.
- Press   keys to select "Ring" and press **[OK]** key to confirm.
- Press   keys to select "Ring volume". Then press **[OK]** key to confirm.
- Press   keys pour to select the desired volume level (from 1 to 3 ), then press **[OK]** key to confirm.

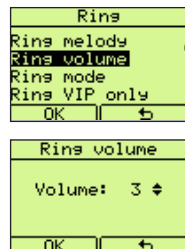







### 2.4.3 Setting the ring mode



It is possible to set the mode the ringer will react when a call incomes, between the following modes:

- Off: no ring (silence)
- On.: immediately when the call incomes
- 2nd ring: start ringing at 2<sup>nd</sup> ring of the incoming call
- At ring nr.: start ringing at a programmed number of rings for that incoming call (3 - 9).

Proceed as follows:

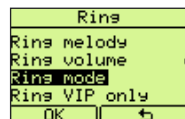
- Press **[Menu]** key to enter in the main menu .
- Scroll the menu items via   keys to select "Settings" and press **[OK]** to confirm.
- Press   keys to select "Ring" and press **[OK]** key to confirm.
- Press   keys to select "Ring mode". Then press **[OK]** key to confirm.





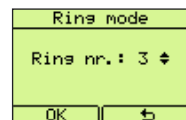
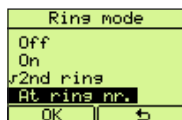

- Press   keys to select the desired mode and press **[OK]** key to confirm.



### 2.4.4 VIP filter

VIP filter allows to activate the ringer for Calling numbers stored in the Vip list only. To activate or deactivate the VIP filter:



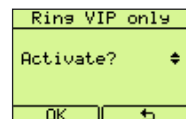
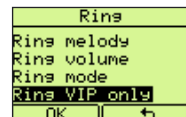

- Enter the menu item "Ring" as described previously
- Select the "Ring VIP only" via   keys, then press **[OK]** key to confirm.
- Choose "Activate?" or "Deactivate?" via   keys and press **[OK]** to confirm.



**This function requires a subscription to the "CLIP/CNIP service".**

### 2.4.5 "No ringer anonymous" filter

When this filter is active, the telephone will not ring in the event of anonymous incoming call. To activate or deactivate the filter, proceed as follows:

- Enter the menu item "Ring" as described previously
- Select the "No Ring anonym." item via   keys, then press **[OK]** key to confirm.
- Choose "Activate?" or "Deactivate?" via   keys and press **[OK]** to confirm.

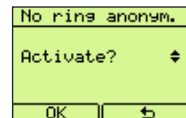
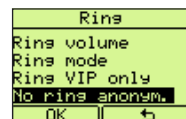

**This function requires a subscription to the "CLIP/CNIP service".**

### 2.4.6 "Black list" filter

When this filter is active, the telephone will not ring for calls incoming from numbers stored in the "Black list". To activate or deactivate the filter, proceed as follows:

- Enter the menu item "Ring" as described previously
- Select the "Black list" item via   keys, then press **[OK]** key to confirm.

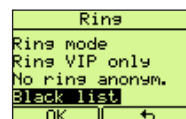







- Choose "Activate?" or "Deactivate?" via   keys and press **[OK]** to confirm.

**This function requires a subscription to the "CLIP/CNIP service".**

## **2.5 Setting the "Fast call"**

The "Fast call" function allows to call all the numbers stored in the memories associated to (0 to 9) keys by holding pressed these keys for 3 seconds. The line is automatically engaged via Hands-free and the number is displayed and sent on to the line.

**To associate a number to a (0 to 9)key, proceed as follows:**

- Press **[Menu]** key to enter in the main menu .
- Scroll the menu items via   keys to select "Settings" and press **[OK]** to confirm.
- Press   keys to select "Fast call" and press **[OK]** key to confirm.
- Press   key to select an empty memory ( 0 to 9) to be programmed.
- Press **[Assign.]** key to confirm
- Enter the desired number, then press **[OK]** key to confirm

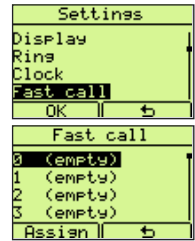

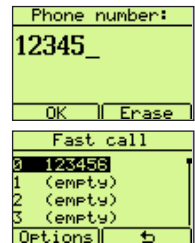

- Press **[↵]** key to go back to idle

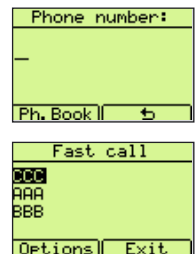

**To associate a Phonebook number to a (0 to 9) key proceed as follows:**

- Repeat the above procedure to select an empty memory ( 0 to 9) to be programmed
- Press **[Assign.]** key to access the "Main menu"



- Press **[Ph. Book]** key and select a Phonebook name/number via   keys.

- Press **[Options]** key and select "Use number".

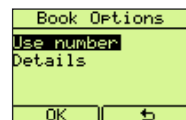

- Press 2 times **[OK]** key to confirm the choice

- Press **[↩]** key to go back to idle

The "Fast call" options allow the user to check (Details), to modify (Edit) and to erase (Erase) a Fast call number. Proceed as follows:

### To check details:

- Select the Fast call memory to be visualized by pressing keys
- Press the **[Options]** key
- Select "Details" by pressing keys and press **[OK]** to confirm. The number is displayed.

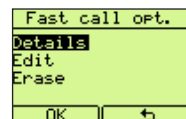

### To modify:







- Select the Fast call memory to be modified by pressing keys.
- Press the **[Options]** key
- Select "Edit" by pressing keys and press **[OK]** to confirm. The number is displayed.
- Erase digits at left side of underscore by pressing **[Erase]** or keys
- Enter new digits and press **[OK]** to confirm. It is possible to enter a number from the Phonebook by erasing all the digits, pressing **[Ph. Book]** key, selecting a name via keys, pressing **[Options]** key and then selecting "Use number". Press **[OK]** key to confirm.

### To erase:

- Select the Fast call memory to be erased by pressing keys.
- Press the **[Options]** key
- Select "Erase" by pressing keys and press 2 times **[OK]** key to confirm.



## **2.6 Setting "Direct call"**

The "Direct call" function allows to call a pre-defined stored number (26 digits max.) by picking up the handset or by pressing the Hands-free key. The number will be sent onto the line after a few seconds. To program a "Direct call" number proceed as follows:

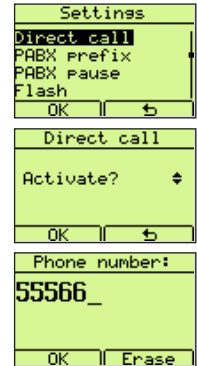
- Press **[Menu]** key to enter in the main menu .
- Scroll the menu items via   keys to select "Settings" and press **[OK]** to confirm.
- Press   keys to select "Direct call" item.
- Press **[OK]** key to confirm. Press   keys to select "Activate?"
- Press **[OK]** key to confirm. Enter the desired number and press **[OK]** key to confirm.
- Press  key to get back to idle.





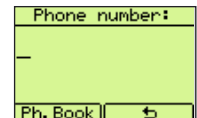

The "Direct call" number can be modified as follows:

- Access the "Direct call" submenu as described and press "Activate" to visualize the number. Erase the complete number or part of it by pressing **[Erase]** key.
- Enter a new number or new digits and press **[OK]** to confirm. It is possible to enter a number from the Phonebook by erasing all the digits, pressing **[Ph. Book]** key, selecting a name via   keys, pressing **[Options]** key and then selecting "Use number". Press **[OK]** key to confirm.



## **2.7 Setting PABX prefix**

It is possible to program a PABX prefix (4 digits max.) as follows:



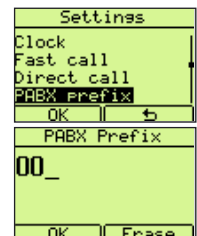



- Press **[Menu]** key to enter in the main menu .
- Scroll the menu items via   keys to select "Settings" and press **[OK]** to confirm.
- Press   keys to select "PABX prefix" and press **[OK]** key to confirm.
- If this memory is empty, enter the prefix (1 to 4 digits) and press **[OK]** key to confirm.





## 2.8 Setting PABX pause





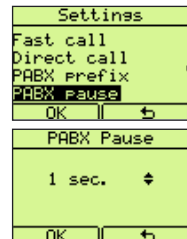

It is possible to program a pause (1 to 4 sec) between the PABX prefix and the number to be called. Proceed as follows:

- Press **[Menu]** key to enter in the main menu .
- Scroll the menu items via   keys to select "Settings" and press **[OK]** to confirm.
- Press   keys to select "PABX pause" and press **[OK]** key to confirm.
- Select the pause time ( 1 to 4 sec.) via   keys and press **[OK]** key to confirm.



## 2.9 Setting Flash time





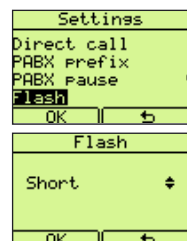

It is possible to program the Flash time as "Short" or "Long". Proceed as follows:

- Press **[Menu]** key to enter in the main menu .
- Scroll the menu items via   keys to select "Settings" and press **[OK]** to confirm.
- Press   keys to select "Flash" and press **[OK]** key to confirm.
- Select the Flash time (Short or Long) via   keys and press **[OK]** key to confirm.



## 2.10 Setting CLI on CW



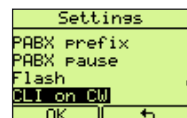

It is possible to activate or deactivate "CLI on CW" function as follows:

- Press **[Menu]** key to enter in the main menu .
- Scroll the menu items via   keys to select "Settings" and press **[OK]** to confirm.
- Press   keys to select "CLI on CW" and press **[OK]** key to confirm.
- Select "Activate?" / "Deactivate?" via   keys and press **[OK]** key to confirm.



## **2.11 Setting the keypad lock PIN**

Proceed as follows:

- Press **[Menu]** key to enter in the main menu .
- Scroll the menu items via   keys to select "Settings" and press **[OK]** to confirm.
- Press   keys to select "Lock PIN" and press **[OK]** key to confirm.
- Enter 4 digits for Lock PIN and press **[OK]** key to confirm.  
N.B. If a lock PIN is already existing, the telephone will immediately ask for it.
- Repeat the 4 entered digits of the Lock PIN and press **[OK]** key to confirm.

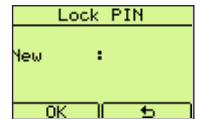





To erase the Lock PIN proceed as follows:

- Repeat the above mentioned procedure and insert a Lock PIN.
- The telephone will ask for a new PIN code.
- Press 2 times the **[OK]** key. The Lock PIN code is erased.

## **2.12 Reset code**

The Reset code is a 4 digits number to set the telephone back to manufacturing configuration. Proceed as follows:

- Press **[Menu]** key to enter in the main menu .
- Scroll the menu items via   keys to select "Settings" and press **[OK]** to confirm.
- Press   keys to select "Reset code" and press **[OK]** key to confirm.

- Enter a 4 digits Code and press **[OK]** key to confirm.

Reset Code

1234 . . . . . to go back to manufacturing condition

0710 . . . . . to go back without erasing Phonebook, Lists, Messages

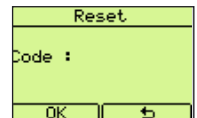



# 3



## USE OF THE TELEPHONE

### **3.1 Connecting and disconnecting from the telephone network**



It is possible to obtain a line in two different ways:

- 1) By picking up the handset.
- 2) By pressing the  key (the display will show the  icon). In both cases, after 10 seconds, the display will show the time elapsed since the line was engaged.

The release of the line is possible as follows:

- 1) By hanging up the handset
- 2) By pressing the  key again (the  icon will disappear from the display).  
The telephone will return to idle mode and the display will show the current time and date.

### **3.2 Hands-free mode**

The Hands free mode enables the telephone to be used without the handset. In this case, it is possible to hear via a loudspeaker located inside the telephone housing. To answer in Hands free mode, press the  key when a call comes. The display will show the  icon and the elapsing time.

### **3.3 Answering to an incoming call**

When a call comes, the telephone starts ringing following the programmed melody.

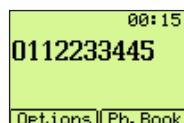
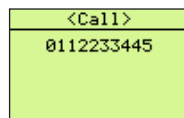

- The writing "Call" is displayed on the top side of the display until the call is answered. If the caller line identification service is activated and available, the number of the caller is displayed after the 1st ring. If the calling number is stored in the Phonebook, the stored name is displayed.
- Pick up the handset or press the  key. The display will show the time elapsed since the line has been engaged (after 10 secs) and the menu "Ph. Book".
- Release the line at the end of the conversation.



## **3.4 Making a call**

### **3.4.1 Normal call**



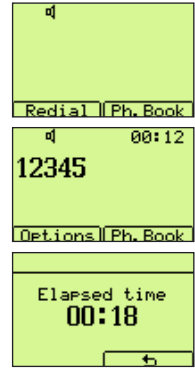

Proceed as follows :

- Pick up the handset or press the  key, then wait for dial tone. The display will show the menu keys "Redial" and "Ph. Book".
- Enter the number to be called. The display will show the time elapsed since the line has been engaged (after 10 secs) and the menu keys "Redial" and "Ph. Book".
- Replace the handset or press the  key at the end of the conversation. The display will show the time elapsed since the line has been engaged (after 10 secs) then it goes back to idle mode.



### **3.4.2 Call with pre-selection**

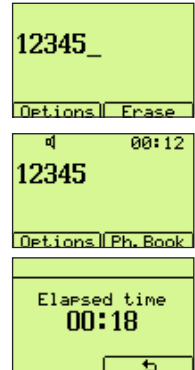

Pre-selection allows the user to compose the number to be dialled out before to engage the line.

- When in idle, enter the number to be called. Pauses may be entered via the  key. In the event of errors, erase (one by one) the digits at the left side of the underscore by pressing the  or the **[Erase]** keys.
- When the number has been entered, pick the handset up (or press the  key). The number is sent. The display will show the communication elapsed time (mm: ss).
- Replace the handset (or press the  key) at the end of the communication. The display will show the communication elapsed time (mm: ss) then it goes back to idle mode.





### **3.4.3 Calling a last number dialled**

The last 30 called numbers are stored in the telephone memory. It is possible to call any of these numbers as follows:

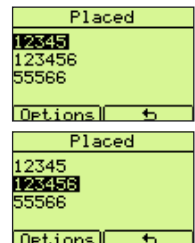

- Press  key to access the last called numbers memory. The list of the last called numbers is displayed.
- Scroll the numbers of the list via   keys to select the name-number to call.



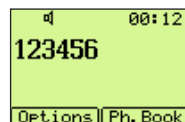

- Engage the line via handset (or by pressing the  key). The selected number is displayed and dialled out. The display will show the communication elapsed time (mm: ss).
- Replace the handset (or press the  key) at the end of the communication. The display will show the communication elapsed time (mm: ss) then it goes back to idle mode.

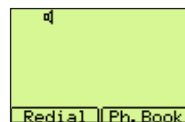

If the line has been engaged (via handset or by pressing  key), and if **[Redial]** is displayed, it is possible to call one of the last dialled numbers as follows:

- Press the **[Redial]** key. The list of the last dialled numbers will be displayed.
- Select the name-number to be called via   keys
- Press the **[Call]** key. The selected number will be immediately dialled out



If the line has been engaged (via handset or by pressing  key), it is possible to call the very last called number as follows:

- Press the  key.

## 3.5 The Phonebook



The Maestro 2055 has a phonebook of 250 name - number (max: 20 characters and 26 digits). It is possible to store up to 3 numbers per name.

### Options of the Phonebook menu:

- Call To call a number of the Phonebook
- Show numbers To see a number of the Phonebook
- Insert new To store a name/number in the Phonebook
- Edit numbers To modify a number of the Phonebook
- Edit name To modify a name of the Phonebook
- Ring melody To associate a melody to a number of the Phonebook
- Ring filter To associate a type of filter to a number of the Phonebook (Normal/VIP/Black)
- Erase To erase a number of the Phonebook
- Show VIP list To access to the VIP list
- Show black list To access to the Black list
- Available memory To check the available memory

### 3.5.1 Storing in the Phonebook





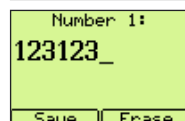
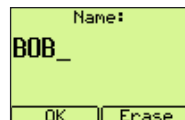
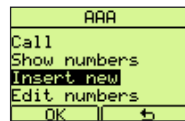

Proceed as follows:

- Press the **[Ph. Book]** key to access the Phonebook. The last number stored or used is displayed.
- Press the **[Options]** key and select the option "Insert new" via   keys.
- Press **[OK]** key to confirm.
- Enter the name of the number to be stored and confirm via **[OK]** key. If the entered name is already used, a message will inform us about this.
- Enter the number (errors may be corrected via **[Erase]** or  keys).
- Press the **[Save]** key. The number is stored.



### 3.5.2 Show numbers of the Phonebook

The option "Show numbers" allows the user to display numbers associated to a name of the Phonebook. Proceed as follows:



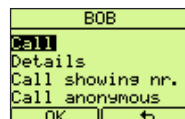
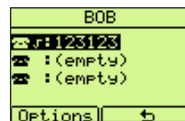
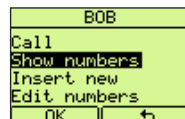
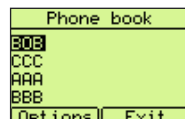

- Press the **[Ph. Book]** key to access the Phonebook. Select a name via   keys.
- Press the **[Options]** key. Select the option "Show numbers" via   keys.
- Press **[OK]** key to confirm. The name and its associated numbers (max 3) are displayed. Select one of the numbers via   keys.
- Press the **[Options]** to access the following menu:
 

Call	to make a call by pressing <b>[OK]</b> or  keys or picking the handset up
Details	to display the parameters of that number
Call showing nr.	to show the number in the event of incoming call
Call anonymous	to not show the number in the event of incoming call
- Choose one of the 4 options and confirm via **[OK]** key.





## 3.5.3 Modify numbers of the Phonebook

In the "Edit numbers" sub-menu, it is possible to display and to personalize a Phonebook number. Proceed as follows:

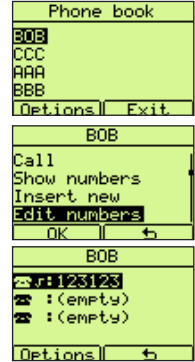
- Press the **[Ph. Book]** key. Select a name to be modified via   keys.
- Press the **[Options]** key. Select "Edit numbers" via   key.
- Press **[OK]** key to confirm. The name and its numbers (max. 3) are displayed.



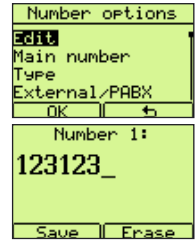

### To modify the number :

- Select one of the 3 numbers associated to that name and press **[Options]** key.
- Select "Edit" via   keys and press **[OK]** to confirm.
- Erase digits at left side of the cursor via **[Erase]** or  keys, insert the modifications and then press **[Save]**.



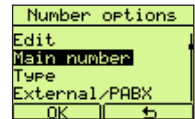

### Setting as "Main number":

- Select one of the 3 numbers associated to that name and press **[Options]** key.
- Select "Main number" via   keys and press **[OK]** to confirm. (The symbol ✓ is displayed at its left side).



Note: this number will be placed at 1st position when making a call.

### To set the type (icon) of number :

- Select one of the 3 numbers associated to that name and press **[Options]** key.
- Select "Type" via   keys and press **[OK]** to confirm. .

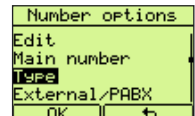

- Choose one of the 4 types (Generic, Mobile, Home, Office) and press 2 times the **[OK]** key to confirm the choice.

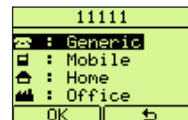

#### To set the type of call (External / PABX):

- Select one of the 3 numbers associated to that name and press **[Options]** key.
- Select "External/PABX" via keys and press **[OK]** to confirm.
- Press the **[Intern.]** key to change to internal or press key to not change.

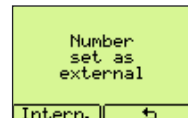
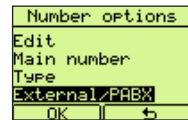

#### To program a SMS Box number (see "Use of SMS service"):

- Select one of the 3 numbers associated to that name and press **[Options]** key.
- Select "SMS Box number" via keys and press **[OK]** to confirm.
- Select a number from 0 to 9 via keys and press **[OK]** key to confirm.

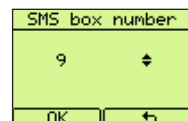
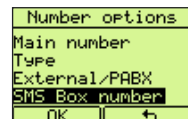

#### To associate a number to a "Fast call" memory :



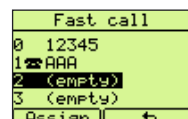
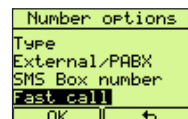

- Select one of the 3 numbers associated to that name and press **[Options]** key.
- Select "Fast call" via keys and press **[OK]** to confirm.
- Select a Fast call memory key (a number from 0 to 9) via keys and press the **[Assign]** key to confirm.





## 3.5.4 Modify names of the Phonebook

In the "Edit name" sub-menu, it is possible to display and to modify the name of a number of the Phonebook. Proceed as follows:

- Press the **[Ph. Book]** key.
- Select a name to be modified via   keys.
- Press the **[Options]** key.
- Select "Edit name" via   keys.
- Press **[OK]** key to confirm. The name is displayed.

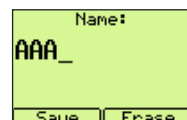
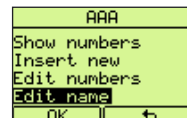



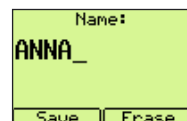



- Erase (modify) the name by pressing the **[Erase]** or  keys. Enter the new name (part of it) and press the **[Save]** to confirm the changes.



## 3.5.5 Modify a Ring melody associated to a name of the Phonebook



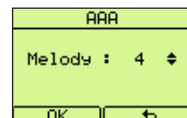
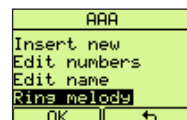

In the "Ring melody" sub-menu, it is possible to display and to modify the melody associated to a name of the Phonebook. Proceed as follows:

- Press the **[Ph. Book]** key.
- Select a name, with the melody to be modified, via   keys.
- Press the **[Options]** key.
- Select "Ring melody" via   keys.
- Press **[OK]** key to confirm.
- Press the   keys to select the new number of melody (from 0 to 15), with 0 corresponding to the default melody .
- Press **[OK]** key to confirm.





### 3.5.6 Ring filter

It is possible to add a Phonebook number to the VIP list or to the Black list: by default, a number is not linked to a list (Normal). Proceed as follows:

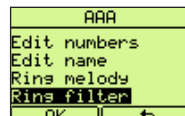
- Press the **[Ph. Book]** key.
- Press the   keys to select the name to be added to the VIP or Black list.
- Press the **[Options]** key.
- Select "Ring filter" via   keys.



- Press **[OK]** key to confirm.
- Select "No filter" or "VIP Ring" or "No ring" via   keys.







- Press **[OK]** key to confirm.

**This function can operate on the Ring if "Ring VIP only" or "Black list" have been activated in the Settings menu (Ring sub-menu).**

If no filter has been activated, the telephone will ring for any incoming call. If "Ring VIP only" has been activated, the telephone rings for calls incoming from numbers of the VIP list. If "Black list" has been activated, the telephone will not ring for calls incoming from numbers of the Black list.

### 3.5.7 Erase a name of the Phonebook

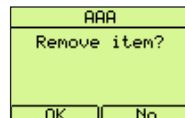
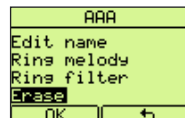

To erase a name (and the associated numbers) of the Phonebook, proceed as follows :

- Press the **[Ph. Book]** key.
- Select the name (to be removed) via   keys.
- Press the **[Options]** key.
- Select "Erase" via   keys and press **[OK]** to confirm.
- Press **[OK]** key to confirm. The name and its numbers are removed.





## 3.5.8 VIP list

The VIP list is a list of names-numbers stored in the VIP memory. To add or to erase an element of this list proceed as follows:

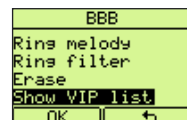
- Press the **[Ph. Book]** key.
- Press the **[Options]** key.
- Select "Show VIP list" via   keys.
- Press **[OK]** key to confirm.





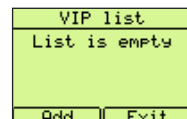

If the VIP list is empty:

- Press the **[Add]** key, choose a name-number of the Phonebook to be added via the   keys, then press **[OK]** to confirm.



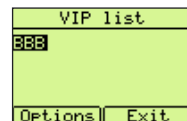

If the VIP list is not empty:

- The names in the list are displayed.
- Press the **[Options]** key.
- Press the   keys to select "Add" or "Remove".
- If "Remove" has been selected, press 2 times the **[OK]** key to confirm the chosen number of the "VIP list" has been removed.
- If "Add" has been selected, press the **[OK]** key to confirm, choose a name-number of the Phonebook to be added via the   keys, then press **[OK]** to confirm.





## 3.5.9 Black list

The Black list is a list of names-numbers stored in the Black memory. To add or to erase an element of this list proceed as follows:

- Press the **[Ph. Book]** key.
- Press the **[Options]** key.
- Select "Show black list" via   keys.
- Press **[OK]** key to confirm.





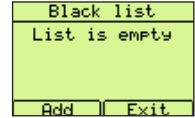

If the Black list is empty:

- Press the **[Add]** key, choose a name-number of the Phonebook to be added via the   keys, then press **[OK]** to confirm.



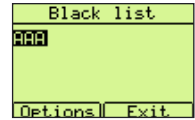

If the Black list is not empty:

- The names in the list are displayed.
- Press the **[Options]** key.
- Press the   keys to select "Add" or "Remove".
- If "Remove" has been selected, press 2 times the **[OK]** key to confirm the chosen number of the "VIP list" has been removed.
- If "Add" has been selected, press the **[OK]** key to confirm, choose a name-number of the Phonebook to be added via the   keys, then press **[OK]** to confirm.







### 3.5.10 Free memory

To check the amount of the Phonebook available memory, proceed as follows :





- Press the **[Ph. Book]** key.
- Press the **[Options]** key.
- Press the   keys to select "Available memory".
- Press **[OK]** key to confirm. The % of the free memory and the numbers of the stored elements will be displayed.

### 3.5.11 Storing a number of the CLI list in the Phonebook

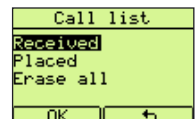
The numbers of the callers, stored in the CLI list, may be stored in the Phonebook as follows:

- Press the **[Menu]** key.
- Press the   keys to select "Call list".
- Press **[OK]** key to confirm.
- Press the   keys to select "Received".





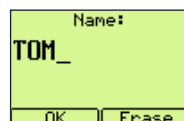
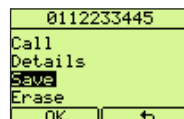
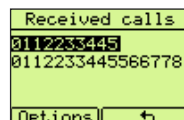







- Press **[OK]** key to confirm. The list of the callers is displayed.
- Scroll the list via   keys and select a name-number.
- Press the **[Options]** key.
- Press the   keys to select "Save".
- Press **[OK]** key to confirm.
- Enter the name (press **[Erase]** or  keys to erase).
- Press **[OK]** key to confirm.



### 3.5.12 Storing a number of the LN dialled list in the Phonebook

One of the last dialled numbers can be stored in the Phonebook as follows:

- Access the list of "Placed" calls in the sub-menu "Call list" by pressing the  key .  
or :
- Press the **[Menu]** key.
- Press the   keys to select "Call list".
- Press **[OK]** key to confirm.
- Press the   keys to select "Placed".
- Press **[OK]** key to confirm. The list of the last dialled numbers is displayed.
- Press   keys to select the last dialled number to be stored in the Phonebook.
- Press the **[Options]** key.
- Press   keys to select "Save".
- Press **[OK]** key to confirm.
- Enter the name (press **[Erase]** or  keys to erase).
- Press **[OK]** key to confirm.

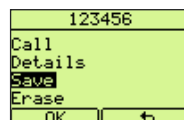
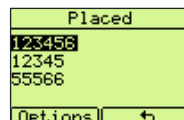

### 3.6 Dialling numbers of the Phonebook / VIP / Fast call

Proceed as follows:

- Press the **[Ph. Book]** key.

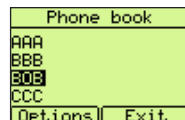

- Select a name-number to be called via   keys.
- Pick the handset up or press the  key to engage the line. The number will be displayed and then dialled out.

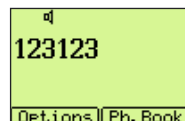



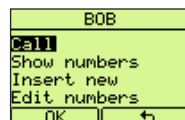

Or:

- Press the **[Options]** key then select the option "Call". The number will be displayed and then dialled out.



#### To dial "VIP list" numbers :

- Press the **[Ph. Book]** key.
- Press the **[Options]** key, then select "Show VIP list" via the   keys and press the **[OK]** key to confirm.
- Select the name-number to be dialled out via the   keys.

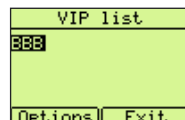
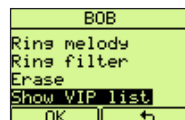

- Pick the handset up or press the  key to engage the line. The number will be displayed and then dialled out.

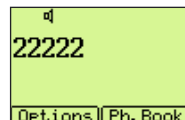

#### To dial "Fast call" numbers:

- Once the telephone is in idle mode, press and hold pressed for a second a key (from 0 to 9) associated to the Fast call number to be dialled. The number will be displayed and then dialled out.

## 3.7 Caller identification

The Maestro 2055 offer the CLIP and CNIP services ( provided by Belgacom under subscription).

- When a call incomes, the handset icon (☎) is displayed if the call has not answered. The name-number of the caller is automatically stored at 1st place of the "Received" list (Call list submenu).
- **This icon disappears after the user accesses the list by pressing the [Show] key and if all the new unanswered calls have been read by using ▲▼ keys.**

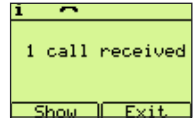

**To display the names-numbers of the list, proceed as follows::**

- Press the [Menu] key.
- Press the ▲▼ keys to select "Call list". Press [OK] key to confirm.
- Press the ▲▼ keys to select "Received". Press [OK] key to confirm.
- The list of the "Received" calls is displayed. The names-numbers of the received unanswered calls are indicated by the symbol ✓. Select a name-number via ▲▼ keys. Press the [Options] key.

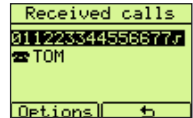
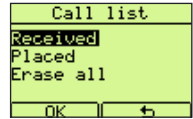

A list of 7 options is displayed:

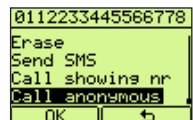
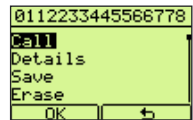

"Call", "Details", "Save", "Erase", "Send SMS", "Call showing nr.", "Call anonymous".

- select "Call" via ▲▼ keys and confirm via [OK] to call the chosen number.
- select "Details" via ▲▼ keys and confirm via [OK] to see Name - number - hour - date.
- select "Save" via ▲▼ keys and confirm via [OK] to save the number in the Phonebook.
- select "Erase" via ▲▼ keys and confirm via [OK] to erase the number.
- select "Send SMS" via ▲▼ keys and confirm via [OK] to use the number as SMS destination number (see SMS: chapter 6).
- select "Call showing nr." via ▲▼ keys and confirm via [OK] to call automatically your partner showing him your number.
- select "Call anonymous" via ▲▼ keys and confirm via [OK] to call automatically your partner showing him your number.



### 3.7.1 Call a number of the "Received" call list

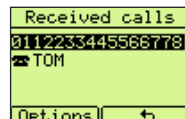

Proceed as follows:

- Visualize the "Received" calls in the "Call list" as described before (3.7).
- Select the number to be called via   keys.







- Pick the handset up or press the  key to engage the line. The number will be displayed and then dialed out.

Or:

- Press the **[Options]** key, select "Call" via   keys and confirm via **[OK]** key. The line is engaged in Hands-free mode and the chosen number will be displayed and then dialed out.

### 3.7.2 Erase numbers of the "Received" call list

Proceed as follows:

- Visualize the "Received" calls in the "Call list" as described before (3.7).
- Select the number to be erased via   keys.
- Press the **[Options]** key.
- Select the option "Erase" via  . Press **[OK]** to confirm.

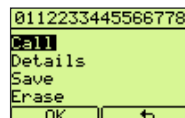

- Press **[OK]** to erase.

To erase all the numbers in the list proceed as follows:

- Press **[Menu]** key.
- Select "Call list" via   keys. Press **[OK]** to confirm.
- Select "Erase all" via   keys. Press **[OK]** to confirm.

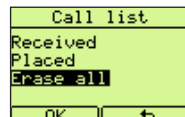

- Select "Received" via   keys. Press **[OK]** to confirm.

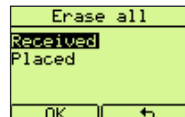





- Press **[OK]** to erase the "Received" call list.



## 3.8 2nd Call handling

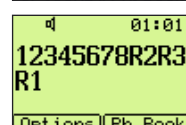
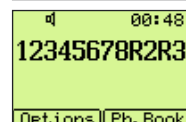
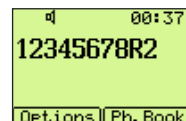
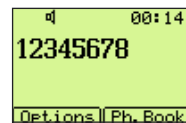

When in conversation an acoustic signal will be heard in the event a 2nd call incomes. The 2nd incoming call number is displayed, if the service is available and if the telephone is set properly. To answer to this 2nd call without releasing the current conversation:

- Press  key to put the 1st call on hold and to answer to the 2<sup>nd</sup> call.
- Press  key to switch between the 2 partners.
- Press  followed by "3" (or press and hold pressed a few seconds the  key) to pass to conferene mode with the other partners
- Press  followed by "1" to end the current conversation and to carry on the other one.
- To end the other conversation too, release the line.



**Note: When a 2nd call incomes, the user may press the [Options] key to use a list of options that can simplify the automatic handling of this function (see chapter 5.2).**

## 3.9 Mute the Microphone

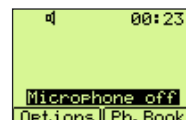

- When in conversation, the user can deactivate the microphone by pressing the  key. The display will show "Microphone off". To make the microphone working, press the  key again. "Microphone off" will disappear.



### 3.10 Loudspeaker volume adjusting



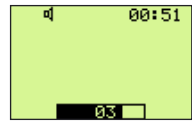

When in conversation, the user can modify the LSP receiving volume level.

#### Hands.free mode (from 1 to 4 levels):



- Press the  key to set the LSP volume up (maximum = 04). Press the  key to set the volume down (minimum = 01).



### 3.11 Group listening mode

When in handset mode, the user can press  key to activate the loudspeaker, allowing the people close to the telephone to listen to the conversation. The user can then go back to handset mode by pressing again  key or switching to hands-free mode by pressing and holding pressed the  key, replacing the handset down and then releasing the  key.

### 3.12 Keyboard lock

- Press the **[Menu]** key.
- Press the   keys to select "Keyboard lock". Press **[OK]** key to confirm. The keyboard is immediately locked.
- To unlock the keyboard, press the **[Unlock]** key and quickly the **[OK]** key. The keyboard is immediately unlocked. If a keyboard lock PIN has been programmed, the telephone will ask for it.









### 3.13 Reminders (alarms)

The user may choose between 6 types of reminders:

- Single it beeps once at the programmed time.
- Yearly it beeps each year at the programmed time.
- Monthly it beeps each month at the programmed time.
- Weekly it beeps each week at the programmed time.
- Daily it beeps each day at the programmed time.
- Hourly it beeps at time intervals equal to programmed numbers of hours.

To program a reminder, proceed as follows:

- Press the **[Menu]** key.
- Select "Reminders" via   keys and press **[OK]** key to confirm.
- Select "New" via   keys and press **[OK]** key to confirm.
- Select a reminder via   keys and press **[OK]** key to confirm.
- Enter the reminder activation time and press **[OK]** key to confirm.



The data to be entered have they own data fields. Press the   keys to pass from a field to another one.

### Reminder - Single :

Enter Day, Month, Year, Hours, Minutes as **dd-mm-yy hh:mm**.

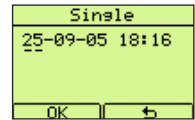

### Reminder - Yearly :

Enter Day, Month, Hours, Minutes as **dd-mm hh:mm**.

### Reminder - Monthly :

Enter Day, Hours, Minutes as **dd hh:mm**.

### Reminder - Weekly :

Enter Day, Hours, Minutes as **ddd hh:mm**.  
Enter the day by selecting ddd field and entering a digit from 1 to 7.  
(1=Sun 2=Mon, 3=Tue, 4=Wed, 5=Thu, 6=Fri, 7=Sat).

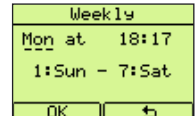

### Reminder - Daily :

Enter Hours, Minutes as **hh:mm**.

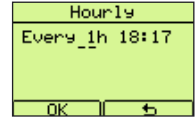

**Reminder - Hourly:**

Enter hourly interval, Hours, Minutes as **ff hh:mm**.





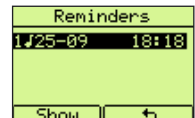
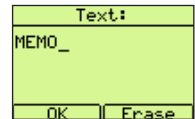

**The entered numeric data must be in the following ranges:**

- dd > 01-31 (depending on the month)
- mm > 01-12
- yy > 05,06, ...etc
- hh > 00-23
- mm > 00-59
- ff > 1-23







**For all the cases:**

- If the entered data are wrong, a message error will be displayed.
- Press **[OK]** key to confirm the entered data. Write a note to be displayed at that reminder time .
- The user may write the note and press **[OK]** key to confirm. The reminder is automatically activated. The Reminders list will be displayed and the Reminders activated will have a melody icon  on their left side.
- When in idle mode, if a reminder has been activated, the icon  is displayed.

**To see the Reminders list and all their associated notes:**

- Press the **[Menu]** key.
- Select "Reminders" via   keys and press **[OK]** key to confirm.
- Select "List" via   keys and press **[OK]** key to display the Reminders list.
- Select a Reminder of the list via   key and press **[Show]** key to display the associated note.

**To Deactivate /Activate a Reminder:**

- Press the **[Menu]** key.
- Select "Reminders" via   keys and press **[OK]** key to confirm.
- Select "List" via   keys and press **[OK]** key to display the Reminders list.
- Select the Reminder to be deactivated / activated via the   keys and press the **[Show]** key. The note is displayed.



- Press the **[Options]** keys, select "Deactivation"/ "Activation" via   keys and press **[OK]** key to confirm. That Reminder is deactivated / activated and the icon  is not displayed / displayed.

### To modify or to erase a Reminder.

1) To modify the time of a Reminder, proceed as follows:

- Select "Edit date" via   keys and press **[OK]** key to confirm.
- Enter the new date and press **[OK]** key to confirm.





2) To modify the note of a Reminder, proceed as follows:

- Select "Edit text" via   keys and press **[OK]** key to confirm.
- Erase the text via **[Erase]** or  keys, enter the new text via the alphanumeric keys and press **[OK]** key to confirm.

3) To erase a selected Reminder, select "Erase" via   keys and press 2 times the **[OK]** .

### To erase all the Reminders.

To erase all the Reminders list, proceed as follows:

- Press the **[Menu]** key.
- Select "Reminders" via   keys and press **[OK]** key to confirm.
- Select "Erase all" via   keys and press 2 times the **[OK]** key.











All the Reminders are erased.

At the programmed time of a Reminder, the telephone beeps and the associated note is displayed. Any action of the user on the telephone, will stop the alerting signal. If no action will be done, the telephone will beep for 1 minute, then the icon  will be displayed.

**When the alert signal beeps, it is possible to press **[Répéter]** to repeat the Reminder 5 minutes later.**

### 3.14 Phone info

The sub-menu "Phone info" allows to display the following infos: "SMS Subaddresses", "Ring settings", "Direct call", "SW release". Proceed as follows:

- Press the **[Menu]** key.
- Select "Phone info" via   keys and press **[OK]** key to confirm.
- Select "SMS Subaddresses" via   keys and press **[OK]** key to confirm. The Boxes and their subaddresses are displayed.
- Press **[Left]** key to go back.
- Select "Ring settings" via   keys and press **[OK]** key to confirm. The ringer settings will be displayed.
- Press **[Left]** key to go back.
- Select "Direct call" via   keys and press **[OK]** key to confirm. The direct number and its activated / deactivated setting will be displayed.
- Press **[Left]** key to go back.
- Select "SW release" via   keys and press **[OK]** key to confirm. The SW version with its date and time of generation will be displayed.

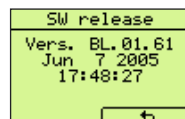
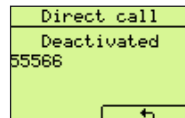
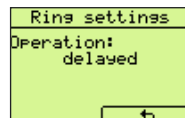
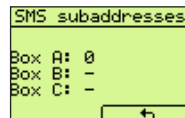
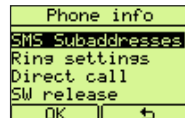

# 4

## NETWORK SERVICES

### 4. Use of Network services

The telephone provides a Network services menu to use in easy mode services as the Call forwarding, the Fixed destination call, the handling of the Call Waiting and the Ring back (CCBS). A few services may be not available on the telephone line; please contact Belgacom to ask for more infos.

#### 4.1 Call forwarding

The service allows the user to forward an incoming call to another telephone number. 3 types of forwarding are offered by Belgacom :

- Call forwarding unconditional (CFU)
- Call forwarding if no reply (CFNR)
- Call forwarding if busy (CFB)

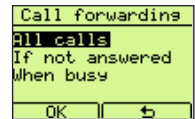

##### 4.1.1 Call forwarding unconditional

All the incoming calls are forwarded to another telephone number. To activate the service, proceed as follows:

- Press the **[Menu]** key.
- Select "Network services" via keys and press **[OK]** key to confirm.
- Select "Call forwarding" via keys and press **[OK]** key to confirm.
- Select "All calls" via keys and press **[OK]** key to confirm.

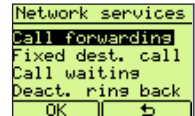

- Select "Activation" via keys and press **[OK]** key to confirm.

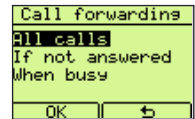

- Enter the number the incoming call will be forwarded to.

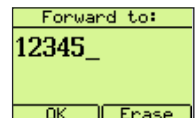
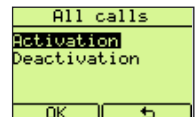



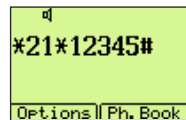





- Press **[OK]** to confirm. The activation code followed by the entered number are displayed, the line is engaged in Hands-free mode and the displayed sequence is dialled out.



- Press the  key to go back to idle.

To deactivate the service, proceed as follows:

- Press the **[Menu]** key.
- Select "Network services" via   keys and press **[OK]** key to confirm.
- Select "Call forwarding" via   keys and press **[OK]** key to confirm.
- Select "All calls" via   keys and press **[OK]** key to confirm.
- Select "Deactivation" via   keys and press **[OK]** key to confirm.

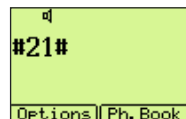
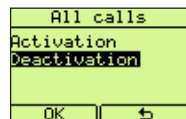







The deactivation code is displayed, the line is engaged in Hands-free mode and the displayed sequence is dialled out.

- Press the  key to go back to idle.

#### 4.1.2 Call forwarding if not reply.

The incoming calls, if not answered, are forwarded to another telephone number. To activate the service, proceed as follows:

- Press the **[Menu]** key.
- Select "Network services" via   keys and press **[OK]** key to confirm.
- Select "Call forwarding" via   keys and press **[OK]** key to confirm.
- Select "If not answered" via   keys and press **[OK]** key to confirm.

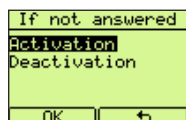
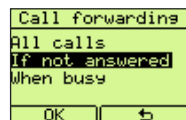

- Select "Activation" via   keys and press **[OK]** key to confirm.

- Enter the number the incoming call will be forwarded to.

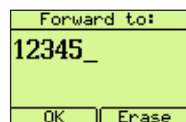



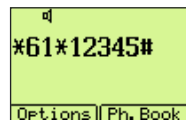





- Press **[OK]** to confirm. The activation code followed by the entered number are displayed, the line is engaged in Hands-free mode and the displayed sequence is dialled out.



- Press the  key to go back to idle.



To deactivate the service, proceed as follows:

- Press the **[Menu]** key.
- Select "Network services" via   keys and press **[OK]** key to confirm.
- Select "Call forwarding" via   keys and press **[OK]** key to confirm.
- Select "If not answered" via   keys and press **[OK]** key to confirm.
- Select "Deactivation" via   keys and press **[OK]** key to confirm.

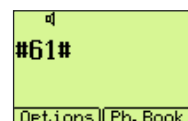
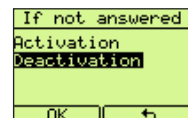







The deactivation code is displayed, the line is engaged in Hands-free mode and the displayed sequence is dialled out.

- Press the  key to go back to idle.

### 4.1.3 Call forwarding when busy

If your telephone is busy and the CW service has not been activated, all the incoming calls will be forwarded to another telephone number.

To activate the service, proceed as follows:

- Press the **[Menu]** key.
- Select "Network services" via   keys and press **[OK]** key to confirm.
- Select "Call forwarding" via   keys and press **[OK]** key to confirm.
- Select "When busy" via   keys and press **[OK]** key to confirm.

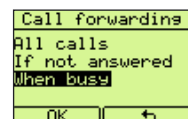

- Select "Activation" via   keys and press **[OK]** key to confirm.

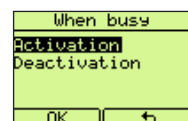

- Enter the number the incoming call will be forwarded to.

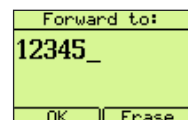



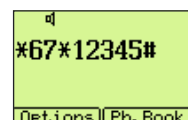





- Press **[OK]** to confirm. The activation code followed by the entered number are displayed, the line is engaged in Hands-free mode and the displayed sequence is dialled out.



- Press the  key to go back to idle.

To deactivate the service, proceed as follows:

- Press the **[Menu]** key.
- Select "Network services" via   keys and press **[OK]** key to confirm.
- Select "Call forwarding" via   keys and press **[OK]** key to confirm.
- Select "When busy" via   keys and press **[OK]** key to confirm.
- Select "Deactivation" via   keys and press **[OK]** key to confirm.

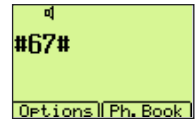
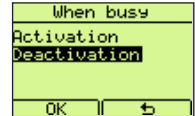







The deactivation code is displayed, the line is engaged in Hands-free mode and the displayed sequence is dialled out.

- Press the  key to go back to idle.

## 4.2 Fixed destination call

The service allows to call a pre-defined number after a few seconds the line has been engaged via handset or by pressing the  key. To activate the service, proceed as follows:

- Press the **[Menu]** key.
- Select "Network services" via   keys and press **[OK]** key to confirm.
- Select "Fixed dest. call" via   keys and press **[OK]** key to confirm.
- Select "Activation" via   keys and press **[OK]** key to confirm.

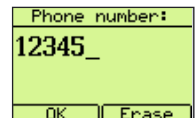
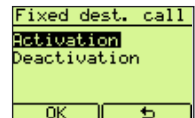
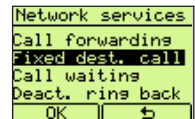





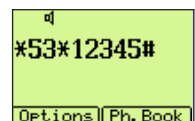

- Enter the Fixed destination number.

- Press **[OK]** to confirm. The activation code followed by the entered number are displayed, the line is engaged in Hands-free mode and the displayed sequence is dialled out. The service is activated.



- Press the  key to go back to idle.

To deactivate the service, proceed as follows:

- Press the **[Menu]** key.
- Select "Network services" via   keys and press **[OK]** key to confirm.
- Select "Fixed dest. call" via   keys and press **[OK]** key to confirm.
- Select "Deactivation" via   keys and press **[OK]** key to confirm.

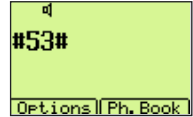
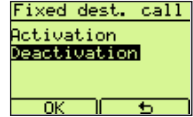



The deactivation code is displayed, the line is engaged in Hands-free mode and the displayed sequence is dialled out.





- Press the  key to go back to idle.

## 4.3 Call waiting (2nd call)



When in conversation mode, if a 2nd call incomes, an acoustic signal is heard (at the earpiece in Hanset mode or at the loudspeaker in Hands-free mode). The calling number is displayed, if the Caller name-number identification and presentation service is available and if the function is properly activated in the telephone. The user can then:

- Press the  key to switch to the 2nd partner and to put the 1st conversation on hold.
- Press the  key to switch between the two partners
- Press **R** and **1** keys to end the on going conversation and to continue the conversation with the other partner.
- Release the line to end this conversation too.

To activate the CW service, proceed as follows:

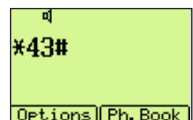
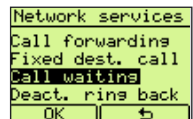
- Press the **[Menu]** key.
- Select "Network services" via   keys and press **[OK]** key to confirm.
- Select "Call waiting" via   keys and press **[OK]** key to confirm.



- Select "Activation" via   keys and press **[OK]** key to confirm. The activation code is displayed, the line is engaged in Hands-free mode and the displayed sequence is dialled out. The service is activated.

- Press the  key to go back to idle.

To deactivate the service, proceed as follows:

- Press the **[Menu]** key.
- Select "Network services" via   keys and press **[OK]** key to confirm.
- Select "Call waiting" via   keys and press **[OK]** key to confirm.
- Select "Deactivation" via   keys and press **[OK]** key to confirm.

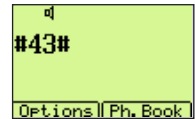
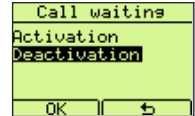

The deactivation code is displayed, the line is engaged in Hands-free mode and the displayed sequence is dialled out.

- Press the  key to go back to idle.





## 4.4 Ring back

The service allow to ask for an automatic call to a called number found busy, when the line will return to be free.

To activate the service:

- Press the  and **5** keys, then release the line.

To deactivate the service :

- When in idle, press the **[Menu]** key.
- Select "Network services" via   keys and press **[OK]** key to confirm.
- Select "Deact. ring back" via   keys and press **[OK]** key to confirm.

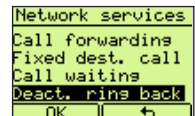

The deactivation code is displayed, the line is engaged in Hands-free mode and the displayed sequence is dialled out.

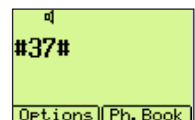

- Press the  key to go back to idle.

## 4.5 PhoneMail and Services

The telephone allows to access easily and quickly to the following list :

Service	No Service	Service	No Service	Service	No Service
PhoneMail	1230	Ecoute Enfants	103	Météo	090027003
1920	1920	Croix rouge	105	Weerbericht	090027002
1930	1930	Rode kruis	105	1207	1207
1940	1940	Tele-onthaal	106	1307	1307
1950	1950	Télé-accueil	107	1407	1407
1919	1919	Telefonhilfe	108	Horloge	1300
100	100	Child Focus	110	Tijdmelding	1200
101	101	Antipoison	070245245	Zeitansage	1400
112	112	Antigift Centrum	070245245		

The  key can operate with or without supply. If supplied, the key can operate in both, idle or line engaged modes.

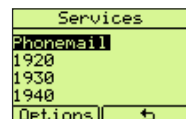

When in idle :

- Press the  key and select the desired service via   keys.





- Press the **[Options]** key to confirm.
- Select the option "Call" and press **[OK]** key to confirm.
- The line will be engaged in Hands-free mode and the code of the selected service is dialled out.

If the telephone has no supply:

- Engage the line via handset
- Press the  key and scroll the list via   keys to select the desired service.
- Press the **[Options]** key to confirm.
- Select the option "Call" and press the **[OK]** key to confirm.
- The number of the selected service is dialled out.

The following Options are available :

- |             |  |
|-------------|--|
| Call        | to call the service number   |
| Details     | to show the service number   |
| Edit name   | to change the service name.<br>Erase via "Erase" or  keys..<br>Insert the new name.     |
| Edit number | to change the service number.<br>Erase via "Erase" or  keys..<br>Insert the new number. |
| Erase       | to remove the service.   |

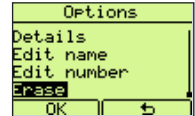
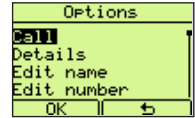

### To check the PhoneMail

When in idle mode, if a new message is in the PhoneMail, the display will show the icon  and the number of messages to be checked.



Check the Phonemail (in both cases : idle or line engaged) as described before. After all the messages have been heard, when in idle the icon and the informations will disappear.

# 5

## ADDITIONAL OPTIONS

### 5 Additional Options

The telephone provides additional options to make easier a few operations.

#### 5.1 Options available in idle mode

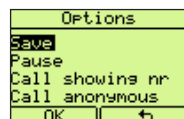

When in idle, if a choosen number is displayed, the user can press the **[Options]** key. The options will be displayed as follows:

- Save
- Pause
- Call showing nr
- Call anonimous



##### 5.1.1 Save a displayed number

This option allows the user to store in the Phonebook a displayed number. Proceed as follows:

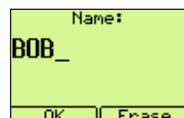

- Display a number.
- Press the **[Options]** keys.
- Select "Save" via   keys
- Press **[OK]** key to confirm.
- Enter the name



- Press **[OK]** key to confirm. The name-number is stored in the Phonebook.

### 5.1.2 Introducing a pause

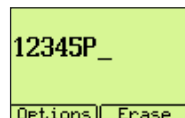

This option allows the user to insert a pause when editing a number . Proceed as follows :

- Edit a number.
- Press the **[Options]** key.
- Select "Pause" via   keys.
- Press **[OK]** key to confirm. The number followed by the pause will be displayed .



### 5.1.3 Make a call as visible

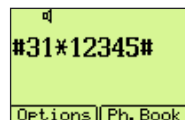

This option allows the user to insert a code before the called number, to be identified by the called partner. Proceed as follows:

- Enter a number.
- Press the **[Options]** key.
- Select "Call showing nr " via   keys.
- Press **[OK]** to confirm. The line is engaged in Hands-free mode and the code #31\* followed by the number is displayed and dialled out.



### 5.1.4 Make a call as anonymous

This option allows the user to insert a restriction code to mask the number to the called user. Proceed as follows:

- Enter a number.
- Press the **[Options]** key.
- Select "Call anonymous " via   keys.
- Press **[OK]** to confirm. The line is engaged in Hands-free mode and the code \*31\* followed by the number is displayed and dialled out.

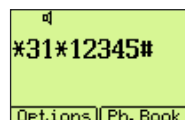



## 5.2 Options in conversation mode

When in conversation, by pressing the **[Options]** key, the following options will be available:

- Act. call-back
- Start 2nd call
- Accept 2nd call
- Alternate
- Conference call
- Call transfer
- Reject 2nd call
- Terminate call

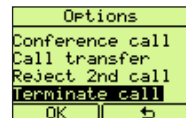
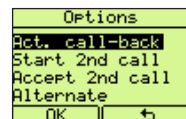

### 5.2.1 Activate call-back

This option allows to call automatically the number of an user called and found busy, when the line becomes free. To activate the service press and **5** keys, then release the line or:

- Press the **[Options]** key, select "Act. call-back" via keys and press **[OK]** key to confirm. This operation sends the code R5 onto the line.

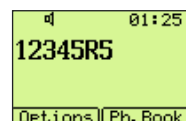

### 5.2.2 Start 2nd call

When in conversation mode, the user can:

- Press the **[Options]** key, select "Start 2nd call" via keys and press **[OK]** to confirm. The R code is sent onto the line and it is possible to make a new call.

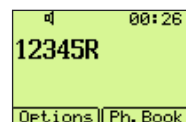

### 5.2.3 Accept 2nd call

When in conversation mode, if a 2nd call incomes, the user can:

- press the key
- or press the **[Options]** key, select "Accept 2nd call" via keys, press the **[OK]** key to confirm and to connect the second partner and putting the first one on hold.

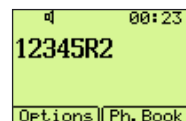

### 5.2.4 Alternate



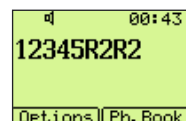

When the user is in conversation with one of two partners, it can:

- press the key
- or press the **[Options]** key, select "Alternate" via keys, press the **[OK]** key to confirm and to switch from one to the other partner.



### 5.2.5 Conference call

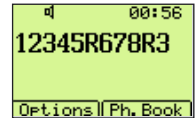

When in conversation, the user can activate a 3 party conference as follows:

- Press the  key followed by the a 2nd party telephone number.
- Talk with the called party
- Activate the conference by pressing **[Options]** key ,select "Conference call" via   keys and press **[OK]** key to confirm (or press and hold pressed for a few seconds the  key). This operation sends the R3 code onto the line and starts the 3 party conference.



### 5.2.6 Call transfer

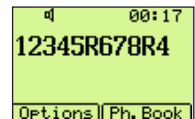

When t in conversation with two partners, one of the two on hold, the user can put the 2 in connection and leave the conversation as follow:

- Activate the Call transfer by pressing **[Options]**, select "Call transfer" via   keys and press **[OK]** to confirm. This operation sends the R4 code onto the line.The 2 other parties are immediately connected each other and the user can leave the line.



### 5.2.7 Reject 2nd call

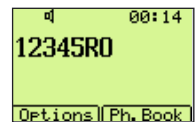

When in conversation mode and if a 2nd call incomes, the user can reject the new call by pressing  and **0** keys or:

- Press the **[Options]** key, select "Reject 2nd call" via   keys and press **[OK]** key to confirm.This operation sends the R0 code onto the line.



### 5.2.8 Terminate call

When the user switch the conversation between 2 parties, he can abandon the party he was talking with and to continue the conversation with the second one by pressing  and **1** or:

- Press the **[Options]** key, select "Terminate call" via   keys and press **[OK]** key to confirm.This operation sends the R1 code onto the line.

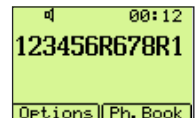

# 6

## USE OF SMS SERVICE

### USE OF SMS SERVICE

The MAESTRO 2055 can send and receive SMS in conformity to the SMS service requirements offered by Belgacom. Three (3) SMS boxes (A,B,C) are available. Box A is available by default. Boxes B and C may be activated by the user. The SMS memory can handle up to 20 messages (inbox +outbox),160 alphanumeric characters for each message.The telephone allows to store up to 80 messages (sent + received) / box depending on the messages lenght. **To use the SMS service, the Maestro 2055 should be set properly, as described in par. 6.1.** Inside the "Messages" menu, select one of the available SMS boxes to make one of the following operations:

Write new	to write a new message
Read received	to access the list of received messages
Read written	to access the list of written messages
Erase messages	to erase received and written messages
Settings	to assign a Box name, a Box number (from 0 to 9),a PIN to access the Box, to activate or deactivate Eatoni function,to deactivate a Boc.
Available memory	to check the % of free memory, the name of the messages received/written

### 6.1 Configuring the SMS service





The MAESTRO 2055 can send and receive SMS. The function is active at delivery and it works if connected to a SMS service center. The SMS center numbers are 1717 for outgoing SMS and 01717 for the incoming SMS. The telephone has a SMS Box number used by the SMS service center. The SMS Box number is 0 by default.

**Important:** if another SMS terminal is already connected to the line, it is important the terminals have different SMS Box numbers.



In this event you **MUST** change the Box A number (0 by default) by following the procedure described in par. 6.1.3. in order to receive properly the SMS messages.The user can check and modify the SMS parameters as follows:

#### 6.1.1 Modify the SMS center numbers

Proceed as follows:

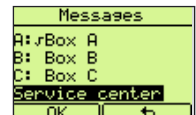







- Press the **[Menu]** key.
- Selectr "Messages" via   keys. Press **[OK]** key to confirm.
- Select "Service center" via   keys. Press **[OK]** key to confirm.



- Select "Service center 1" or "Service center 2" via   keys and press **[OK]** key to confirm.
- Modify the Service center number (erase via **[Erase]** or  keys and enter the new number)
- Press **[OK]** key to confirm.

### 6.1.2 Assign a name to a SMS Box





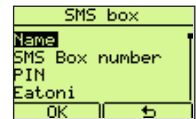





Proceed as follows:

- Press the **[Menu]** key.
- Select "Messages" via   keys. Press **[OK]** key to confirm.
- Select a Box via   keys. Press **[OK]** key to confirm.
- Select "Settings" via   keys. Press **[OK]** key to confirm.
- Select "Name" via   keys. Press **[OK]** key to confirm.
- Modify the SMS Box name (erase via **[Erase]** or  keys) and enter a new name.
- Press **[OK]** key to confirm.



### 6.1.3 Assign a number to a SMS Box

Proceed as follows:

- Press the **[Menu]** key.
- Select "Messages" via   keys. Press **[OK]** key to confirm.
- Select a Box via   keys. Press **[OK]** key to confirm.
- Select "Settings" via   keys. Press **[OK]** key to confirm.
- Select "SMS Box number" via   keys. Press **[OK]** key to confirm..
- Choose a Box number (from 0 to 9) via   keys or by pressing a 0 to 9 key of the keyboard. Press **[OK]** key to confirm..

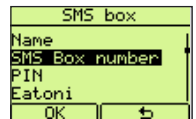

### 6.1.4 Assign a Pin code to a SMS Box

Proceed as follows:

- Press the **[Menu]** key.
- Select "Messages" via   keys. Press **[OK]** key to confirm.
- Select a Box via   keys. Press **[OK]** key to confirm.
- Select "Settings" via   keys. Press **[OK]** key to confirm.
- Select "PIN" via   keys. Press **[OK]** key to confirm.

If no PIN has been entered yet "New :": is displayed. Enter a PIN (from 1 to 4 digits) and press **[OK]** key to confirm.

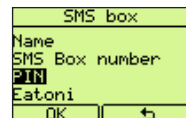





- The message "Repeat:" will be displayed. Enter the PIN again and press **[OK]** key to confirm.



### 6.1.5 Activate / Deactivate EATONI function

Eatoni function (predictive - text system for letters choice) helps the user to write SMS messages.

To activate / deactivate this function, proceed as follows:

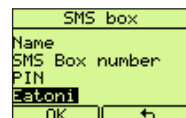







- Press the **[Menu]** key.
- Select "Messages" via   keys. Press **[OK]** key to confirm.
- Select a Box via   keys. Press **[OK]** key to confirm.
- Select "Settings" via   keys. Press **[OK]** key to confirm.
- Select "Eatoni" via   keys. Press **[OK]** key to confirm.



- Select "Activate?" or "Deactivate?" via   keys.
- Press **[OK]** key to confirm the choice.

### 6.1.6 Deactivate a SMS Box



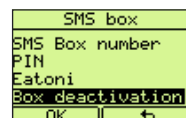

Proceed as follows:

- Press the **[Menu]** key.
- Select "Messages" via   keys. Press **[OK]** key to confirm.
- Select a Box via   keys. Press **[OK]** key to confirm.
- Select "Settings" via   keys. Press **[OK]** key to confirm.
- Select "Box deactivation" via   keys. Press **[OK]** key to confirm.



### 6.1.7 Activate a SMS Box

Proceed as follows:





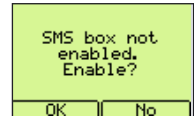



- Press the **[Menu]** key.
- Select "Messages" via   keys. Press **[OK]** key to confirm.
- Select a not enabled Box via   keys. Press **[OK]** key to confirm.
- "SMS box not enabled. Enable?" is displayed. Press **[OK]** key to confirm.

Note : An activated SMS Box will have the symbol  displayed at left side of its name.



## 6.2 SMS Sending

Proceed as follows:

- Press the **[Menu]** key.
- Select "Messages" via   keys. Press **[OK]** key to confirm.
- Select an activated Box via   keys. Press **[OK]** key to confirm.
- If a PIN code has been programmed, the telephone will ask for it. Enter the PIN, press **[OK]** key to confirm and to access the SMS messages menu. The list of "Messages" options is displayed.
- Select "Write new" via   keys and press **[OK]** key to confirm.
- Enter the text via the alphanumeric keyboard by pressing a few times the keys to choose the characters you need. A counter on the top of the screen displays the number of entered characters (see table of characters at chapter 6.4.).
- When entering the text it is possible to erase the characters at left side of the cursor via  and **[Erase]** keys.
- After the text has been entered, press the **[Options]** key to display the options list.
- Select "Send" via   keys and press **[OK]** key to confirm.

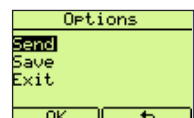
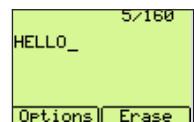
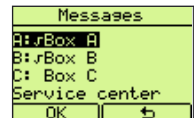
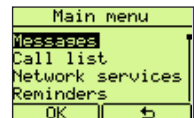

- Enter the destination phone number:
  - 1) Manually
  - Or
  - 2) Press the **[Ph.Book]** key and select a Phonebook name-number.
- Press the **[Options]** key, select "Send" and press **[OK]** key to confirm.
- Select the SMS Box number (from 0 to 9) of the user you want to send the message via **▲▼** keys.
- Press **[Send]** to confirm. The telephone connects automatically the SMS service center to send the message out. The result of the SMS sending will be displayed.

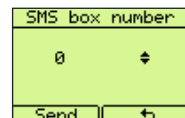
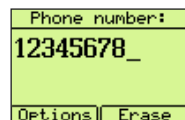



## 6.2.1 Reading and Options of the SMS sent

Proceed as follows:

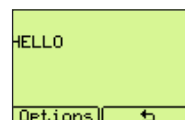
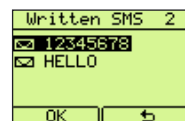
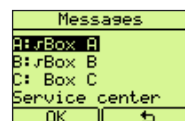
- Press the **[Menu]** key.
- Select "Messages" via **▲▼** keys. Press **[OK]** key to confirm.
- Select an activated Box via **▲▼** keys. Press **[OK]** key to confirm.
- If a PIN code has been programmed, the telephone will ask for it. Enter the PIN, press **[OK]** key to confirm and to access the SMS messages menu. The list of "Messages" options is displayed..
- Select "Read written" via **▲▼** keys and press **[OK]** to confirm. The list of the destination numbers of the written SMS will be displayed.
- Select a destination number via **▲▼** keys and press **[OK]** to confirm. The message is displayed.
- Press the **[Options]** key to access the "Options" sub-menu.



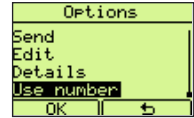
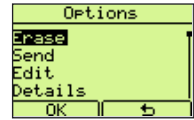

► Press the   keys to select the desired option :

- |             |   |
|-------------|---|
| Erase       | to erase the displayed message and its parameters   |
| Send        | to send out the displayed message   |
| Edit        | to modify the displayed message   |
| Details     | to display info of the message (destination number, box destination number, date and hour of message sending) |
| Use number. | to save in the Phonebook or to call the number  |









## 6.3 SMS Receiving

In the event of a call incoming from a SMS center, the Maestro 2055 answer automatically to receive the message (if the box of destination has been activated). The icon  is displayed when a message has been received. If the memory of the receiving box cannot contain a new message, the icon  will be displayed.

The user can erase some message received or tend some message written and stored but not yet sent out.

### 6.3.1 Reading received SMS

Proceed as follows:

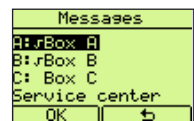
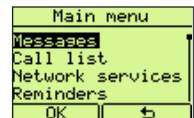
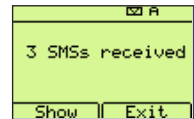

- If displayed, press the **[Show]** key to access "Messages" menu
- If **[Show]** is not displayed, press the **[Menu]** key. Select "Messages" via   keys and press **[OK]** key to confirm.
- Select the desired Box via   key. Press **[OK]** key to confirm.
- If a PIN code has been programmed, the Maestro 2055 will ask for it.
- Enter the PIN code, press **[OK]** key to confirm and to access the SMS menu. The list of "Messages" options is displayed.
- Select "Read received" via   keys and press **[OK]** key to confirme. The list of received messages is displayed. The last received message is displayed at 1st place.



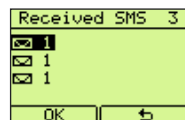

➤ Select the desired number via   key and press **[OK]** key. The message is displayed.



➤ Press the   keys to scroll the complete message.

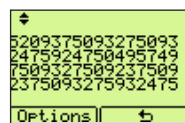

## 6.3.2 Options menu "Read received"

After a message has been received, press the **[Options]** key to access sub-menu "Options". The user can press   keys to select:

- Erase to erase received messages
- Reply to write a new SMS and to send it to the displayed number
- Forward to forward the received message to a new user number
- Edit to modify the received SMS and its parameters via **[Erase]** and  keys. The new message may then be sent out or saved.
- Details to show infos concerning the SMS (sender number, sender box number, date and hour of sending))
- Use number to save the number into the Phonebook or to call the number.

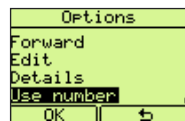
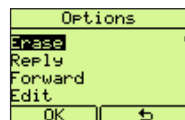

## 6.4 EATONI (SMS only)

Eatoni (predictive method for the letters choice ) is a function that make easier a SMS message writing. The function can be activated/deactivated when configuring a SMS box (see chapter 6.1.5). When the user writes a SMS message by pressing an alphanumeric key, the display shows the most probable letter related to that key and to the text of the message.

If the letter shown is not the good one, press # key to change it.

The \* key allows to enter many characters an symbols.

The 0 key allows to enter a space between characters.

Starting to write a new message, the alphanumeric keys generate small letters. It is possible to generate capital letters, digits and symbols by selecting the desired function in the "Options" menu.

Pressing the **[Options]** key, the display shows:

- Send
- Save
- Numbers
- Uppercase
- Symbols
- Exit

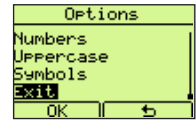
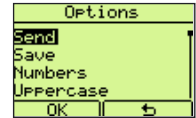

The user can choose the desired item of the "Options" menu. If "Numbers" has been chosen, "Letters" will take its place. If "Uppercase" has been chosen, "Lowercase" will take its place. If "Symbols" has been chosen, the user can select the desired symbol via keys and to confirm it via **[OK]** key.

The association key - characters is described in the following table:

Key	alphanumeric characters
1	. , !   1
2	A B C 2 a b c Æ Ç à æ ? ¿ € £ \$
3	D E F 3 d e f É é è % " ' _
4	G H I 4 g h i _
5	J K L 5 j k l - + =
6	M N O 6 m n o Ñ ñ ( < ^
7	P Q R S 7 p q r s / \
8	T U V 8 t u v Ü ù ü : ; & §
9	W X Y Z 9 w x y z ) >
0	space @ 0
#	If the letter is not the good one, press # key to change it
*	@ . , !   ? ¿ € £ \$ % " ' _ - + = ( < ^ / \ : ; & § ) > * # { } [ ] ~

The equipment that you bought has required the extraction and use of natural resources for its production. It may contain hazardous substances for the health and the environment.

In order to avoid the dissemination of those substances in our environment and to diminish the pressure on the natural resources, we encourage you to use the appropriate take-back systems. Those systems will reuse or recycle most of the materials of your end life equipment in a sound way.

The crossed-bin symbol invites you to use those systems.

If you need more information on the collection, reuse and recycling systems, please contact your local or regional waste administration.

You can also contact us for more information on the environmental performances of our products.

## Please keep in a safe place

➤ Equipment.

.....

➤ Series Number

.....

➤ Date of purchase, replacement or repair \*

.....

➤ Name and address of the purchaser:

.....

.....

.....

➤ Telephone number of the department concerned

.....

➤ Stamp

.....

\*delete as appropriate

## Warranty

Selected with care by Belgacom, the terminal equipment you have bought is covered by a parts and labour warranty against all equipment flaws or manufacturing defects for a period of two years, unless any contractual provisions are made to the contrary. The warranty takes effect from the redemption or delivery date of the equipment. Any call-out by Belgacom staff is not covered by the warranty.

If you experience any difficulties with your equipment, you may give the telephone book one of our phone shops and authorized sellers making sure that you are in possession of this certificate together with the complete item of equipment in its original packaging or in some other that affords similar security. The addresses of our phone shops appear in the information pages of Telephone directories.

In the event of any flaw in the equipment or manufacturing defect, your equipment will be repaired or replaced free of charge upon presentation of the ticket of purchasing. Belgacom alone shall determine what repairs and/or replacements are needed. The warranty period that applies to any equipment that is repaired or replaced shall expire on the expiry date of the equipment purchased, but shall not be less than 3 months.

The warranty does not cover:

- damage of any kind the origin of which was not occur prior to the sale;
- damage, disturbances or defects that are attributed to any fault of the customer and whose cause is external to the equipment: lightening, surges in voltage, humidity, accidental damage, improper use or poor maintenance, the failure to comply with the instructions on use as well as any kind of accident;
- the repair or replacement of detachable parts (flexes, plugs, aerials, etc...), the replacement of accessories whose regular renewal is necessary (batteries, paper, ink, etc...) or the supply or cleaning products.

The warranty shall not apply:

- if the customer modifies or repairs the terminal equipment him/herself or via services supplied by persons who are not accredited by Belgacom;
- if he/she removes or falsifies the manufacturer's numbers and/or the marking on the terminal equipment.

Belgacom may not be held responsible for any indirect or unsubstantial damage sustained by the customer as a result of the incorrect functioning of the machine such as any loss in production, loss of income or loss of contracts.

**The general sale terms of our terminal equipment may be obtained by simply making a request to any Belgacom department open to the public and on internet site [www.belgacom.be](http://www.belgacom.be).**

**Belgacom SA under public law, Bd. du Roi Albert II 27, B-1030 Brussels  
VAT BE 0202.239.951, Brussels Register of Legal Entities**