

# Forum™ 500

# Forum™ 5000

**Forum Phone 515**  
**Forum Phone 525**  
**Forum Phone 535**

User Guide



## Welcome to Proximus

Thank you very much for choosing this Proximus product. Our product meets the strictest requirements with regard to design and quality.

## Forum Phone 515, 525, 535

This User Guide will show you how to use your Forum Phone 515, Forum Phone 525 or Forum Phone 535 and answer all your major questions. If you need further support or information, please consult your system administrator or your Proximus dealer.

Internet:

[www.proximus.be/pabx](http://www.proximus.be/pabx)

## Forum™ 5000 and Forum™ 500

This user guide applies to the Forum™ 5000 and Forum™ 500 product families.

- The Forum™ 500 product family comprises the Forum™ 523/524, Forum™ 525/526 and Forum™ 550/560 communications systems.
- The Forum™ 5000 product family comprises the Forum™ 5500, Forum™ 5004, Forum™ 5008 and Forum™ 5012 communications systems.

If individual features differ on the systems, a reference is made in this user guide.

We hope you enjoy using your Forum Phone.

# Contents

## Forum Phone 515/525/535 System Telephones .....7

<b>Using Your Telephone</b> .....	<b>8</b>
Safety Precautions.....	8
Installation Site.....	9
Cleaning.....	9
Attaching the Pedestals and Adjusting the Inclination.....	10
Wall Mounting.....	11
<b>Key Assignments</b> .....	<b>12</b>
Dial Keypad with ABC Assignment.....	15
Trunk Key (Call Key 1).....	15
Programmable Keys.....	16
Redial Key.....	17
ABC Key.....	17
MenuCard Key.....	17
C-Key.....	17
Info Key.....	18
Hands-Free/Open-Listening Key.....	18
Muting Key.....	19
Disconnect Key.....	19
Headset Key.....	19
Enquiry Key.....	19
Plus/Minus Key.....	19
ESC Key.....	20
Arrow Key.....	20
OK Key.....	20
The Locking of Your Telephone Interface by the System Administrator.....	20
Labelling the Keys.....	21
<b>Display and MenuCards</b> .....	<b>23</b>
Changing the Language.....	23
Info Line(s).....	23
Key Lines.....	24
MenuCard Display.....	26
Invoking MenuCards and Selecting Items from the List.....	26
Setting Windows and their Characteristics, Toggling.....	28
Entering/Deleting Digits.....	28

Deleting Lists .....	29
Entering Text .....	29
Automatic Exit .....	30
<b>Key Extensions .....</b>	<b>31</b>
Operating the Key Extension Keys .....	32
Choosing a Key Level .....	32
Labelling a Key on the Key Extension .....	33
<b>Using a Headset .....</b>	<b>33</b>

## **Telephoning..... 38**

<b>In a hurry? A Brief Explanation of Important Functions .....</b>	<b>38</b>
Talking on the Phone: Via the Call Key or the Handset.....	38
Telephoning.....	39
Redialling .....	41
Receiving Calls .....	42
Who Called? .....	42
Querying/Toggling, Transferring .....	43
Audio: Muting, Open-Listening, Adjusting Telephone Volume.....	46
<b>General Functions .....</b>	<b>47</b>
Assignment of Internal and External Call Numbers .....	47
Signalling on the Call Keys .....	47
Calls in the Call Waiting Queue .....	48
Accepting a Call During Automatic Dialling .....	49
Block Dialling/Automatic Dialling .....	49
Muting .....	51
Call-charge Display, Duration Display .....	51
Adjusting the Volume with the Plus/Minus Key .....	51
Redialling .....	51
Hands-free Mode, Open-listening Mode .....	53
Blocked/Unblocked Call Numbers .....	53
Telephone Lock .....	53
DTMF Postdial/VF Signalling .....	54
Keypad Dialling .....	54
Least Cost Routing (LCR) .....	54
Transmission of Call Numbers .....	55
MenuCards Before and During a Call .....	56
MenuCard “Selection” in the Idle State .....	57

<b>Making External/Internal Calls</b> .....	<b>58</b>
Manual or Automatic Line Seizure .....	58
Making an External Call .....	59
Making an Internal Call .....	60
Using Destination Keys to Make Calls .....	61
Call Waiting with an Internal Subscriber .....	61
Using Routes to Make Calls .....	62
Busy Display for Bundles and Routes on the System Telephone .....	62
Ending Calls .....	63
MenuCard “Conversation” .....	63
MenuCard “Busy” .....	66
<b>Accepting Calls</b> .....	<b>67</b>
By Lifting the Handset or Pressing a Key .....	67
Automatic Call Connection .....	68
Calls During a Conversation .....	69
MenuCard “Call Waiting” .....	70
MenuCard “Call” .....	70
Voicebox Queries .....	70
<b>Enquiry, Toggling, Transfer and Conference</b> .....	<b>71</b>
Enquiry/Toggling by means of the R-Key or Another Call Key .....	71
Transferring an Internal/External Call to an Internal Subscriber .....	71
Transferring an External Call to an External Subscriber .....	72
MenuCard “Subscr (Subscriber) on hold” .....	73
Internal/External Three-Party Conference .....	73
MenuCard “Conference” .....	74
<b>Special Calls/Functions</b> .....	<b>75</b>
Accepting an Appointment Call .....	75
Baby Call .....	75
Announcements (with and without Intercom) .....	75
Answering a Callback .....	78
Forwarding Calls .....	78
Caller History .....	80
Call Recording .....	82
Automatic Call Recording .....	84
Doorbell, Door Opener .....	85
Entrance Intercom Calls .....	86

<b>Making Calls from the Telephone Book</b> .....	<b>87</b>
The Telephone Book.....	87
MenuCard “Phone book”.....	88
Speed-Dialling .....	89
Add Phone Numbers to Telephone Book from Lists or during a Call ..	89
<b>Hot Desking: Your Telephone Goes Wherever Your Desk Is</b> .....	<b>92</b>
<b>VoIP Telephones</b> .....	<b>95</b>
IP System Telephone Ports .....	96
Notes for the System Administrator .....	97
<b>Team Functions</b> .....	<b>98</b>
<b>Managing Calls in a Team</b> .....	<b>98</b>
Making External/Internal Calls .....	98
Accepting Calls .....	99
Enquiry, Toggling and Transferring .....	100
<b>Programming the Call Keys</b> .....	<b>102</b>
MenuCard “Prog. call key” (Trunk Key) .....	102
MenuCard “Prog. team key” .....	104
Direct-call Key .....	104
<b>Remote-Controlled Functions</b> .....	<b>105</b>
Remote-Controlled Dialling (Call Through) .....	105
Remote-Programmable Call Forwarding .....	107
Remote-Programmable Voicebox Configuration and Query ...	108
Setting up an Internet Connection from Remote (ISP Trigger Call) .....	109
<b>Features and MenuCards</b> .....	<b>110</b>
How to Set Features .....	110
<b>Main Menu</b> .....	<b>110</b>
MenuCard “Main Menu” .....	110
MenuCard “Calls” .....	112
MenuCard “Call Forwarding” .....	117
MenuCard “Messages” .....	119
MenuCard “Phone Settings” .....	121

MenuCard “Protection”	123
MenuCard “Connections”	125
MenuCard “Phone Book”	130
MenuCard “Applications”	133
MenuCard “Central Settings”	133
<b>Shortcut Menus</b>	<b>134</b>
MenuCard “Info”	134
MenuCard “Active Features”	135
MenuCard “Prog. call key”	135
MenuCard “Prog. team key”	136
<b>Programming Keys</b>	<b>136</b>
Programming Call Numbers (Destinations)	136
Programming Functions (Features)	138
Stacking or Linking Functions	140
Status Key	142
<b>Busy Keys</b>	<b>143</b>
Programming the “Call number” Busy Key on the Terminal	144
Using the Busy Key “Call Number”	146
Using the Busy Key “Device”	147
<b>Appendix</b>	<b>148</b>
Environmental Information	148
Tones and Ringer Signals	149
<b>Index</b>	<b>150</b>
<b>Support</b>	<b>157</b>





---

# Forum Phone 515/525/535 System Telephones

The Forum Phone 515, Forum Phone 525 and Forum Phone 535 are corded system telephones that you can operate on your Forum 500 / Forum 5000 communications system. The MenuCard display makes your telephone easy to operate and gives you fast access to your system's wide range of different functions and features.

The Forum Phone 525 and the Forum Phone 535 have the same functionality. The only difference between them is the size of the display and the number of programmable keys available. The Forum Phone 515 offers the most functions of these two telephones with the following exceptions: the Forum Phone 515 has just one trunk key available (please refer to page 15) and the "Hot Desking" feature is not supported (please refer to page 92). The Forum Phone 525 and Forum Phone 535 telephones can also be expanded via additional key extensions which offer additional programmable keys (please refer to page 31).

The Forum Phone 525 and the Forum Phone 535 are also available as IP telephones (Forum IPhone 525 and Forum IPhone 535). These telephones have the same functionality as the standard system telephones. All of the functions described in this guide are also available for the IP telephones. The chapter *VoIP Telephones* starting on page 95 contains a short summary of the information necessary for the IP system telephone user.

You can activate the features and programme functions on the telephones themselves, or equally conveniently, use the **Configurator** of the communications system.

## About this user guide

The description of the various functions of your system telephone covers (unfortunately) many pages. Not every user has the time and leisure to read the guide from start to finish before telephoning for the first time. The following chapters are **mandatory** reading before using your telephone:

- *Safety Precautions* starting on page 8: These tips are for your own safety and help you to protect the telephone from damage!
- *Installation Site* starting on page 9

- *Key Assignments* starting on page 12 and *Display and MenuCards* starting on page 23: Here is an overview of the features of your telephone.
- *In a hurry? A Brief Explanation of Important Functions* starting on page 38: Read this chapter for quick telephoning access.

Take enough time to also read the rest of this user guide and familiarize yourself with the features of your telephone. You will become acquainted with many new functions which you can use for the practical organisation of your communications. Use the index for fast information access of individual functions.

### The glossary

Should you need further information about any system features described in this user guide, please read the “Glossary” which comes with your communications system.

### You need authorisation

Most of the features mentioned in this user guide are only available to you if you have the appropriate authorisation. This will be set up by your system administrator when configuring the communications system. If you are unable to use a particular feature or have any questions, consult your system administrator.

# Using Your Telephone

## Safety Precautions

---

**WARNING!** Do not open the telephone or the connected accessories, as this could lead to you touching live parts.

---

**Note:** Repairs must only be carried out by authorised Proximus service personnel.

- Keep fluids and chemicals away from the telephone and its accessories.
- Use only the AC adapter plug included in the delivery (product code 90035810) where necessary.
- Do not use AC adapter plugs that show visible damage (e. g. cracks in the housing).

- Connected headsets must conform with the standard DIN EN 60 950-1, Point 6.2 (“Safety of information technology equipment including electrical business equipment”).

Please contact your customer consultant if you require further information about the connectable headsets, adapters and adapter cables.

- Use a shielded CAT-5 Ethernet cable (STP cable, Shielded Twisted Pair cable) to connect an IP telephone to a Local Area Network (LAN).
- Make sure that no one can trip over the telephone cables.

## Installation Site

Do not install the telephone or its accessories

- near water, moisture or in damp locations;
- near sources of heat or in direct sunlight;
- in unventilated rooms;
- near devices that generate strong magnetic fields, electrical devices, fluorescent lamps, computers, radios or television sets;
- in dusty places or places subjected to vibrations, shocks or extreme temperature fluctuations.

Place the telephones on a non-slip surface. The surface finish of your furniture may affect the telephone’s pedestals, softening them and causing them to leave undesirable marks on your furniture.

## Cleaning

Simply wipe your telephone with an antistatic or slightly damp cloth. Never use a dry cloth or a cleaning agent.

## Attaching the Pedestals and Adjusting the Inclination

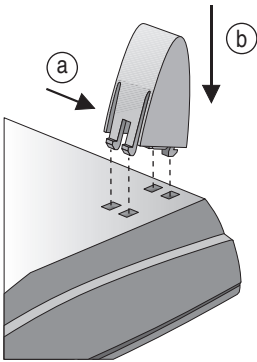

Forum Phone 515

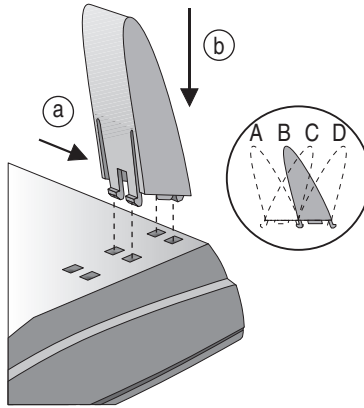

Forum Phone 525 / Forum Phone 535

To pull the pedestals out, press them in slightly (a). To replace them, press the pedestals in slightly (a) and push them back in (b). The pedestals lock into place in the notches.

There are four positions of inclination possible on the Forum Phone 525 and on the Forum Phone 535 (see A, B, C and D), depending upon the direction in which the pedestals have been attached.

Inclination position	Degree of inclination
A	30°
B	26,5°
C	23°
D	21°

## Wall Mounting

To mount your telephone to the wall, remove the pedestals. Using a screwdriver, pry the retention pin (1) for the handset out of its receptacle, turn it upside down (2) and insert it again.

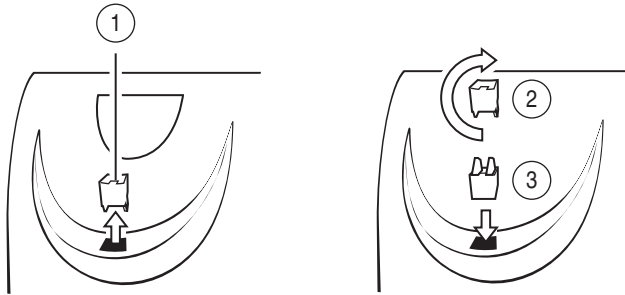

To mount your telephone to the wall, drill two holes at 119 mm distance apart. Insert 6 mm screws in the holes. Make sure their heads protrude 2.5 to 3 mm from the wall and mount the telephone onto the screws.

# Key Assignments

Some of the keys have dual functionality (depending on whether you long or short press the key). The “MenuCards” described below are windows that are displayed to enable you to set features and functions. For more details, refer to the section entitled *Display and MenuCards* starting on page 23.

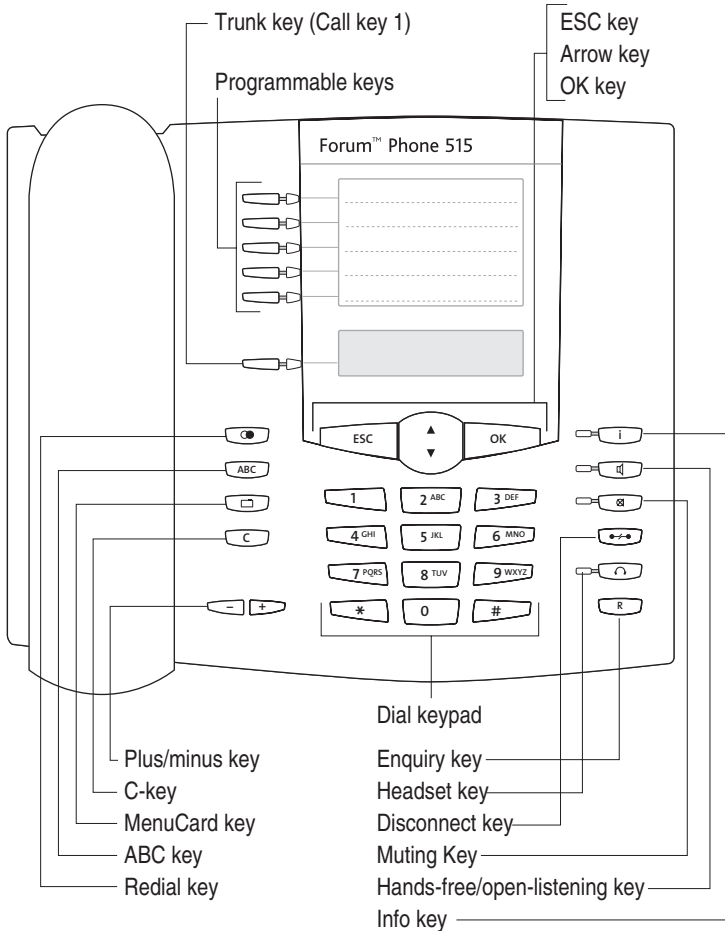

*Key assignment on the Forum Phone 515*

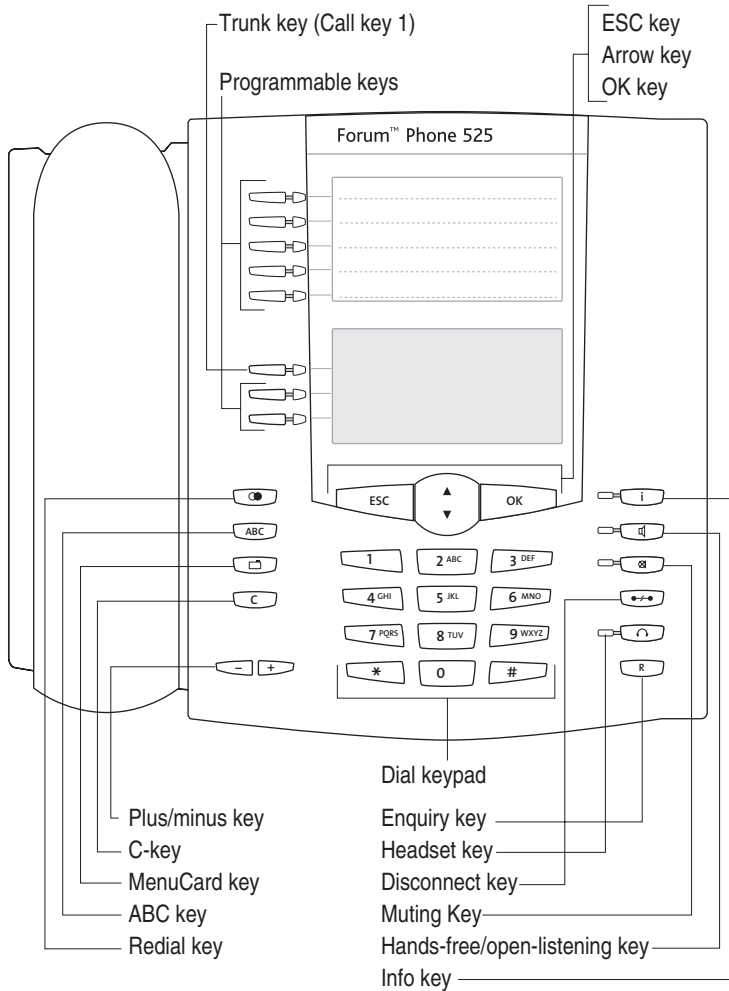

*Key assignment on the Forum Phone 525*

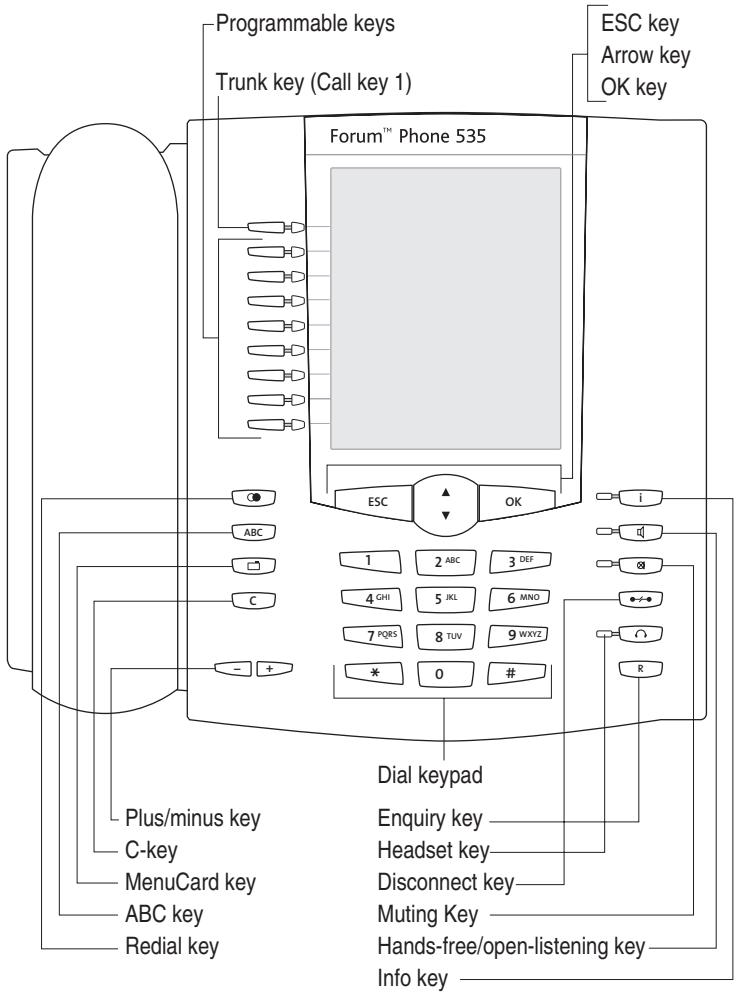

*Key assignment on the Forum Phone 535*



## Dial Keypad with ABC Assignment

 This is for dialling call numbers or entering text. The key label does not show all the available letters and special characters. For more information, refer to the section entitled *Entering Text* on page 29.

## Trunk Key (Call Key 1)

 The trunk key of the telephone (also: call key 1) is occupied by your internal call number (main number). The key is located to the left of the display, and is labelled with your internal call number (or optionally, with a text programmed by the system administrator). Refer to the respective illustration in the chapter *Key Assignments* starting on page 12 to determine the position of the key on your equipment. Your internal call number is assigned to an external call number where you can be reached when being called from an external number. It is possible to assign several external call numbers to the key. If you wish to make a call, lifting the handset seizes the key (and the trunk line); you can immediately dial an internal or external number (depending on the system setting). Long pressing the key displays a MenuCard which allows you to programme the key's settings (see the section entitled *MenuCard "Prog. call key"* starting on page 135).

A system setting makes it possible to have your internal number assigned to other telephones as well. Calls will then be signalled to other telephones simultaneously.

The LED of the key indicates the current status, see also the chapter *Signalling on the Call Keys* starting on page 47.

### For the system administrator: setting the trunk keys of the system telephones

- The internal call number for a system telephone is configured in the **Configurator, Telephony > Ports > Upn** menu or for IP phones respectively in the **Configurator > Telephony: Devices > VoIP phones** menu. The assigned internal call number is automatically allocated to the trunk key (call key 1).
- The assignment to external call numbers takes place in the **Configurator, Telephony > Call distribution** menu.

## Programmable Keys

 The additional keys to the left of the display are free programmable keys. The system administrator can assign other internal call numbers to these keys for you as additional trunk keys (call keys). These keys have also been assigned to external call numbers at which you can be reached from an external number. In order to make a call with a trunk key, first press the key and then dial the call number.

**Note:** Only call key 1 can be configured as a trunk key on the Forum Phone 515 system phone (please refer to page 15).

The system administrator can also assign the programmable keys as call keys for team functions. Information on the use of team functions can be found in the chapter *Team Functions* starting on page 98.

The LEDs of the programmed keys indicate different states, see also the chapter *Signalling on the Call Keys* starting on page 47.

You can programme features and destination call numbers yourself directly on the programmable keys of the device that have not been set by the system administrator. See the chapters on *Programming Functions (Features)* starting on page 138 and *Programming Call Numbers (Destinations)* starting on page 136 for more information. To use a configured programmable key, do the following:

- Short key press: The programmed destination call number is dialled or the programmed function (feature) is carried out.
- Long key press: The key can be programmed with a MenuCard.

### **For the system administrator: configuring the keys of a system telephone**

- The keys of the system telephones can be programmed in the **Configurator, Telephony > Devices > System phones** menu.
- In the **Configurator, Telephony > Groups** menu you can set up teams and programme team functions for the system telephones of the team members. In the “Team Functions” chapter of the “Mounting and Commissioning” (Forum 523/524, Forum 525/526, Forum 550/560, Forum 5004/5008/5012) resp. “Commissioning and Maintenance” (Forum 5500) guide you will find examples and explanations of various possible team configurations.

## Redial Key

 Opens a list of the last-dialled numbers.

## ABC Key



- Short key press: Opens the MenuCard for the telephone book. When entering texts (please refer to page 29 also) one can switch between the alphanumeric and numeric modes.
- Long key press: Opens the list of the available display languages.

**Note:** You need the appropriate authorisation to operate this key on your system telephone. Consult your system administrator if your authorisation has to be changed.

## MenuCard Key

 Shows MenuCards in the display.

- Short key press: A selection of features that can be used in the current device status (e. g. during a call) is shown.
- Long key press: The MenuCard for the Main menu with all available settings is shown.



**Note:** You need the appropriate authorisation to operate this key on your system telephone. Consult your system administrator if your authorisation has to be changed.

## C-Key

 (Clear key) to delete input, entries and lists.

- Short key press: Input (for example the last digit of an entered call number) or list entries in the menu (for example, an entry in the call list) will be deleted.
- Long key press: A complete entry or an entire list (for example, the call list) will be deleted.

## Info Key

 Indicates incoming calls (LED flashes quickly, the bell  is shown in the display), receiving incoming messages and current telephone settings.

- Short key press: Displays a MenuCard with received messages (the LED of the key flashes slowly).
- Long key press: Displays a MenuCard with a list of active features, which restrict the reachability of the telephone (e. g., call protection is on). The illuminated LED of the key indicates that the reachability of the telephone is restricted or that the telephone lock is activated (see also *Telephone Lock* on page 53).

**Note:** You can accept an incoming call by pressing the info key. The hands-free mode is switched on. If you use a headset with your system telephone, the headset is switched on (see page 122).

## Hands-Free/Open-Listening Key

 To make calls using the microphone and/or loudspeaker. The illuminated LED of the key indicates that hands-free telephoning is activated. The LED flashes when open-listening is activated.

Situation:	By pressing the key:
You receive a call.	You accept the call without picking up the handset (hands-free mode, the LED is illuminated).
You have dialled a call number (block dialling/automatic dialling).	The call number is dialled.
You have selected a call number from the telephone book.	The call number is dialled.
You are making a call via the handset and want to let a second person listen in on the call.	The loudspeaker is switched on (open-listening mode, the LED flashes).
You are making a call via the handset and wish to switch to hands-free mode.	Keep the key depressed and replace the handset. Then release the hands-free/open-listening key. You can continue the call in hands-free mode.

## Muting Key

 To deactivate the microphone during a call. The LED of the key is illuminated when the microphone is deactivated. The ringer of your telephone can be switched off for incoming calls over the muting key.

## Disconnect Key

 Pressing this key ends the current call.

## Headset Key

 If a headset is connected and switched on (to switch on a headset, see page 122), calls can be accepted and calls can be ended by pressing this key. The LED of the key is illuminated when a call is made via the headset.

It is also possible to enable a second person to listen in on a call over a connected headset while you are telephoning over the handset. To enable, press the headset key during the call. Listening-in over the headset is now activated, the LED on the headset key flashes.

## Enquiry Key

 To initiate and end an enquiry call. After you have ended an enquiry call, switch back to the call being held with this key.

## Plus/Minus Key

 This key offers various functions which depend on the device status:

- It adjusts the volume during open-listening/hands-free mode.
- It adjusts the volume when making a call via the handset.
- It adjusts the volume of the headphones of a headset (the volume of the **microphone** can be adjusted over the **4 Phone settings** MenuCard, see page 122).
- It adjusts the volume of the ringer tone during a call.
- It sets the contrast of the display when the telephone is in the idle state.
- It switches features on/off quickly.
- It changes the volume of the ringer tone and the melody in the **4 Phone settings** MenuCard.

- It moves the cursor when entering call numbers or text.

**Tip:** If you have already used the plus/minus key to open a menu to set the display contrast or the volume, your current setting will automatically be applied after three seconds, without your using the OK key  to confirm.

## ESC Key

 (Escape key) navigates the menu.

- Short key press: Exits an open input window without changing its contents and/or returns you to the menu branches.
- Long key press: Exits the menu.

## Arrow Key

 This key is used to scroll through the MenuCards and lists.

## OK Key

 This key is used to confirm the selected menu items, functions or settings.

## The Locking of Your Telephone Interface by the System Administrator

The system administrator can lock your telephone's interface via a setting for your user group. All keys of your telephone no longer function aside from a few exceptions (e. g. the number keys and the call key 1).

- You can then make calls with your telephone but no system functionality can be configured.
- If the system administrator has authorised you to do so, you can also set the time group of the communications system (see also *MenuCard "Central Settings"* starting on page 133). If your user group authorisation changes according to the time group, then it is possible that the interface lock of your telephone will be cancelled.

Please consult your system administrator if you have any questions about your authorisations.

**For the system administrator: locking the keys on the system telephone**

Administer authorisation of which keys are functional on the system telephone and which keys are locked over the **Configurator**, **User manager > User groups** menu.

## Labelling the Keys

### Label strip

The five keys above the display on the Forum Phone 515 and on the Forum Phone 525 can be assigned with destinations or functions (features) or programmed as call keys. (The programming as call keys isn't possible on the Forum Phone 515, see also page 16.) The programming/assignment does not appear in the display. The label strips provided are for labelling these keys. A label strip is also used for labelling keys on a key extension Forum 500 Keypad Paper FP 525/535.

Proceed as follows to label the insert:

- Press down slightly on the bottom part of the cover and slide it up to remove it. Remove the label strip.
- Replace the printed strips.
- Insert the cover in the slot and slide it down until it snaps into place.

### Printing label strips

Using the **Configurator** of the Web console, you can print the labels for a selected system telephone with the current key assignment (**Telephony > Devices > System phones** menu).

### Key labelling on the display

The keys to the left of the display of the system telephones are also freely programmable (one key on the Forum Phone 515, three keys on the Forum Phone 525, nine keys on the Forum Phone 535). These keys are labelled with a default text that you can change during or after programming. One of these keys is pre-programmed as a trunk key (see also *Trunk Key (Call Key 1)* starting on page 15), the text on this key can also be changed. The key labelling also appears in the display on the key extension Forum 500 Keypad Display FP 535.

### Labelling a key



Press the key (**long key press**), then ...



select **Modify text**.



Press the OK key.



In the following MenuCard under **Text**: enter the text (see also the chapter *Entering Text* starting on page 29).



Press the OK key twice.

The keys can also be labelled in the **Configurator** of the Web console (in the **Telephony > Devices > System phones** menu). If the key labelling is changed in the above mentioned manner or on the key extension, the new text will also be displayed in the Configurator. Conversely, the modified texts will overwrite the display texts on the telephone or key extension.

Information regarding the aforementioned key extensions can be found in the chapter *Key Extensions* starting on page 31.



# Display and MenuCards

## Changing the Language

Use the following procedure to set the display language:



Press the ABC key (long key press).



Using the arrow key scroll to the desired setting.



Confirm the setting with the OK key.

In the Main menu you can use the **4 Phone settings** MenuCard to change the language (see page 122).

## Info Line(s)

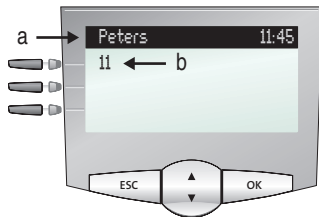

*The Forum Phone 525's display in idle state, here:*

**a** Info line displaying the user's name and the time

**b** The user's internal call number

The first (and on the Forum Phone 535 also the second) line of the display shows additional current information. When the telephone is idle, you can see the user's name as assigned to the device in the **Configurator** of the Web console by the system administrator and the time (the Forum Phone 535 also displays the day of the week and the date). For the system telephones Forum Phone 515 / Forum Phone 525, the system administrator can adjust the setting so that the date is shown instead of the user name.

**For the system administrator: configuring the display of the user name and the date**

Assign the user name in the **Configurator, User manager > User** menu. Configure the display of the date in the info line of the Forum Phone 515 / Forum Phone 525 system telephones in the **Configurator, Telephony > Settings** menu.

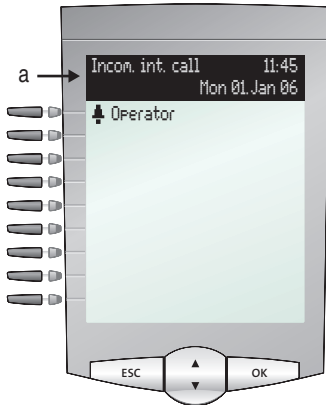

*The Forum Phone 535's display in call state:*  
**a** Info lines

During a call, the current charge counter (if configured) and annotation texts are displayed. During an enquiry call you will see the number of the enquiry call you dialled. On the Forum Phone 535 the second info line is used to display connection information also, you can, for example, view the capacity status of a call queue. If there is an entry in the phone book for the called subscriber (see also page 130), name and call number are displayed alternately in the calling state.

## Key Lines

The display next to the keys is assigned to them on a line-by-line basis. Depending on the type of key, the following display texts are shown. On the Forum Phone 515 the display always shows the active line.

**Note:** The call and seizure states are identified by additional symbols on the call keys. For details, refer to the section entitled *Telephoning* starting on page 38.

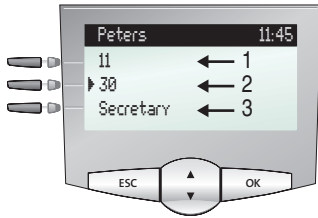

*Key lines on the Forum Phone 525:*

- 1** Call key in idle state: internal call number or a user-assigned text.
- 2** Call key during dial and connection state: dialled call number.
- 3** Destination key with names programmed: programmed name.

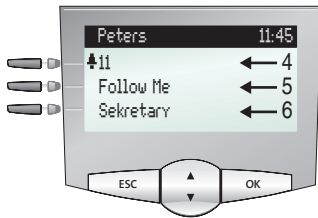

*Key lines on the Forum Phone 525:*

- 4** Call key during call state: call number (if transmitted) or the name of the caller (if listed in the telephone book).
- 5** Feature key programmed: name of feature with status display.
- 6** Destination key with name programmed. If no name was programmed, the display shows the programmed call number instead of the name.

## MenuCard Display

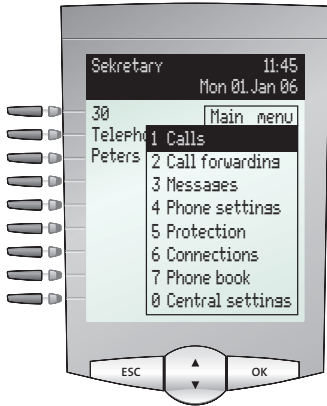

### *MenuCard display on the Forum Phone 535*

All the features of your telephone and the system are controlled via display windows like the ones on your PC. These display windows look like index cards and are called MenuCards. On the Forum Phone 515 the display shows the active line of the MenuCard.

MenuCards are displayed using different keys. Please refer to the explanations in the section entitled *Key Assignments* on page 12.





The top line of a MenuCard contains the name of the menu or that of the selected feature. The lines below it contain all the selectable features or lists of names and call numbers.

A MenuCard covers some of the key lines, but it is still possible to execute all the functions (features) assigned to the keys (e. g. accepting a call on a call key).





## Invoking MenuCards and Selecting Items from the List

Use the keys described in the section entitled *Key Assignments* starting on page 12 to invoke a MenuCard (see the table entitled *Invoking MenuCards via the Keypad* on page 27). Note when a short or a long press of a key is required. Selecting list entries is described in the table entitled *Selecting Items from MenuCard Lists* on page 27.

## Invoking MenuCards via the Keypad

Key	Short	Long	MenuCard	Page
MenuCard key 	x		Depends on the device's status	--
		x	Main menu	110
Info key 	x		Info / current messages	134
		x	Active features	135
ABC key 	x		Telephone book	130
		x	Language setting (display)	23
Redial key 	x	x	Redialling list	51
Programmable key 		x	Programme the key (destination key or feature key)	136

## Selecting Items from MenuCard Lists

Arrow key 	The arrow key is used to select items in and/or scroll through the MenuCard lists. If the list is longer than the display window, you will see an arrow at the bottom of the window indicating there are additional items. When the first entry in a menu is selected and you press the up arrow key ▲ you go to the last entry of this menu. When the last entry in a menu is selected and you press the down arrow key ▼ you go to the last entry.
Number keys 	In the Main menu, you can also make your selection by entering the number to the left of the feature.
OK key 	Pressing this key confirms your selection or setting. Depending on the feature, it is now executed and you can exit the MenuCard, or additional setting windows are displayed.
Escape key, short press 	This cancels your selection/entry without making any changes and takes you back to the next highest branch of the menu tree.

## Selecting Items from MenuCard Lists

Escape key,  
long press





This closes the MenuCard without making any changes.

## Setting Windows and their Characteristics, Toggling



*Forum Phone 525's display*

Two dots following a MenuCard item mean: After pressing the OK key  a sub-menu is opened in which you can select options or make entries. The settings in the sub-menu are stored after pressing the OK key .

A “+” sign to the left of the name of a feature indicates that it is activated and a “-” sign that it is deactivated.

The plus/minus key  lets you toggle between the on/off states, while the OK key moves you to the next item in the setting window.



## Entering/Deleting Digits





*Forum Phone 525's display*

In an input line (e. g. for a call number) you can make entries/changes straight away. The cursor indicates the position at which the input or deletion is made.

If numerical inputs are longer than the display field, the digits disappear off the display to the left.





Using the plus/minus key  you can move the cursor and display the digits that were previously not visible. The digits on the right will then disappear from the display field. Inputs are always made to the immediate left of the cursor position. A short press of the C-key  deletes individual digits, whereas a long press deletes the complete entry.



## Deleting Lists



In displayed lists (e. g. the call list) you delete individual items from the list with a short press of the C-key . Long pressing the C-key  deletes the entire list, but only after the query **Are you sure?**. Press  to delete the list.

## Entering Text

In input lines for text, the numerical keypad automatically switches to the entry of letters. You can enter the following characters by repeatedly pressing the number keys:

Key	Characters
	1?!,:;“”
	ABC2ÄÅÀÁÂÃÄÅÆÇ
	DEF3ÈÉÊËË(Euro sign)
	GHI4ÌÍÏ
	JKL5
	MNO6ÑÖÏÒÓÔÕØ
	PQRS7ß
	TUV8ÜÙÚÛ
	WXYZ9
	0-(space)@ \$ &

Key	Characters
	* - + = < > ^ %
	# () {} [] / \

- Inputs are always made to the immediate left of the cursor position.
- The input position moves automatically if you pause briefly between your inputs or if you enter a new character.
- When entering text, the first letter will automatically be upper case, the remaining letters automatically lower case. After you enter a space, the next letter will be upper case once again.
- While entering text, you may switch back and forth between upper and lower case by pressing a number key for a **longer** time. The upper-/lower-case remains activated until the next time you press a number key longer.
- Press the ABC key  briefly to switch between the alphanumeric and numeric modes.
- If the text passages are more than one line long, line breaks are made automatically at the end of each line. You can move the cursor by using the plus/minus key .
- A short press of the C key  deletes individual digits/characters (in front of the cursor), whereas long pressing the key deletes the complete entry.

## Automatic Exit

MenuCards close automatically under the following conditions:

- An open menu is automatically closed after 60 seconds if you do not make any additional entries. Exception: playing back a voicebox message with a duration longer than a minute. Changes that have not been saved are lost.
- In the idle or connection state, if you receive a call and accept it by lifting the handset or pressing a key.
- In the connection state, if you make inputs that require a new connection-dependent MenuCard (e. g. you pressed the R-key  to make an enquiry call; see the section entitled *Telephoning* starting on page 38).
- If you press a key that invokes a MenuCard other than the one displayed.



All inputs that have been saved in the MenuCards remain intact when you exit the menu.

## Key Extensions

With a key extension, you can extend your system telephone Forum Phone 525 and Forum Phone 535 with additional free programmable keys. The Main menu functions and destination call numbers can be stored on these keys. In addition, the system administrator can programme call keys (trunk keys, team keys, busy keys or direct-call keys) over the configuration software of the communications system.

Up to three key extensions can be connected to system telephones: either three key extensions of the model Forum 500 Keypad Paper FP 525/53 or three key extensions of the model Forum 500 Keypad Display FP 535. A combination of these key extensions is, however, not possible.

The following equipment combinations are possible:

Key extension ...	... with the features	Connectable to a system telephone
Forum 500 Keypad Paper FP 525/535	<ul style="list-style-type: none"> <li>– 36 keys with LED indicator</li> <li>– Labelling on label strips</li> </ul>	<ul style="list-style-type: none"> <li>– Forum Phone 525</li> <li>– Forum IPhone 525</li> <li>– Forum Phone 535</li> <li>– Forum IPhone 535</li> </ul>
Forum 500 Keypad Display FP 535	<ul style="list-style-type: none"> <li>– 20 keys with LED indicator</li> <li>– 3 keys with LED indicator to shift levels; enables programming of 60 storage locations on each key extension</li> <li>– Labelling of the keys over the display; each key is assigned to a display line</li> </ul>	<ul style="list-style-type: none"> <li>– Forum Phone 535</li> <li>– Forum IPhone 535</li> </ul>

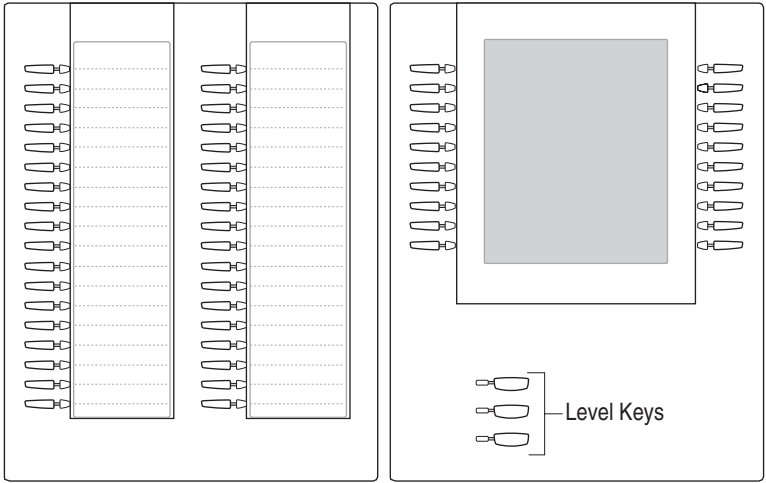

Fig. left: Key extension Forum 500 Keypad Paper FP 525/535;  
Fig. right: Key extension Forum 500 Keypad Display FP 535

**For the system administrator**

In the “Mounting and Commissioning” (Forum 523/524, Forum 525/526, Forum 550/560, Forum 5004/5008/5012) resp. “Commissioning and Maintenance” (Forum 5500) guide you will find the corresponding assembly instructions in the chapter “Connecting the Key Extension”.

## Operating the Key Extension Keys

The keys of the key extension are used in the same way as programmed keys, as described in this user guide (see the following sections: *Programming Call Numbers (Destinations)* starting on page 136, *Programming Functions (Features)* starting on page 138, *Programming the Call Keys* starting on page 102).

## Choosing a Key Level

Keys can be programmed on three levels with a key extension Forum 500 Keypad Display FP 535. There are a total of 60 storage locations available on 20 keys.

To toggle between the levels, use the level keys  on the lower left. The illuminated LEDs next to the key indicates that the level is activated. In the

display of the key extension, you will also see the text with which this storage location is labelled.

A key extension Forum 500 Keypad Display FP 525/535 offers only one level.

## Labelling a Key on the Key Extension

Paper strips are used for labelling the key on the Forum 500 Keypad Display FP 525/535 key extension. The keys are either labelled with the default text on the Forum 500 Keypad Display FP 535 (e. g. when programming a feature key) or by entering an individual text when programming the key (see also the chapter *Labelling the Keys* starting on page 21).



## Using a Headset



















You can telephone hands-free if you use a headset. A headset connected to a system telephone can be switched on and off at the telephone (see also page 122 in the chapter entitled *MenuCard "Phone Settings"*). If the headset is switched on, you can accept or end a call by pressing the headset key  on the system telephone, which switches off the microphone and handset on the telephone. If the headset is switched off, the headset key operating function on the system telephone is not operational.













**Note:** If a cordless DHS/G headset is used, the headset key  on the system telephone can be operated with the Talk key on the headset.



















Read the instructions for the headset in the user guide.





The headset can be used in combination with the handset and the other keys of your system telephone (e. g. hands-free/open-listening key ). The following table gives an overview of the different operating situations. The headset must be switched on for these operations (see page 122).

Situation:	Operation:	Result:
You receive a call.	Press the headset key 	You telephone with the headset (LED of the key  is illuminated).
	or press the call key  .	

Situation:	Operation:	Result:
<p>You want to make a call.</p>	<p>Press the headset key  and enter the call number </p>	<p>The call number is dialled (LED of the key  is illuminated).</p>
	<p><b>or</b> press the call key  and enter the call number </p>	
	<p><b>and when necessary</b> press the hands-free/open-listening key .</p>	<p>Hands-free/open-listening is switched on (LED of the key  flashes).</p>
<p>You have entered a call number (block dialling/automatic dialling).</p>	<p>Press the headset key </p>	<p>The call number is dialled (LED of the key  is illuminated).</p>
	<p><b>or</b> press the call key </p>	
	<p><b>and when necessary</b> press the hands-free/open-listening key .</p>	<p>Hands-free/open-listening is switched on (LED of the key  flashes).</p>
<p>You are telephoning over the handset and want to switch to the headset.</p>	<p>Press the headset key , <b>keep it pressed</b> and replace the handset .</p>	<p>You continue the call over the headset (LED of the key  is illuminated).</p>
<p>You are telephoning in hands-free/open-listening mode (the handset is on-hook, LED of the key  is illuminated); you want to switch to the headset.</p>	<p>Press the headset key .</p>	<p>Hands-free/open-listening is ended (LED of the key  is off); you continue the call over the headset (LED of the key  is illuminated).</p>

Situation:	Operation:	Result:
You are telephoning over the handset and want to let a second person listen in on the call over the headset.	Press the headset key  .	Listening-in over the headset is now activated (LED of the key  flashes).  <b>End listening-in:</b> Press the headset key  (LED of the key  is off).
You are telephoning over the headset and want to let a second person listen in on the call.	☒ Pick up the handset	The second person listens in on the call over the handset (LED of the key  is illuminated).  <b>End listening-in:</b> ☒ Replace the handset (LED of the key  is illuminated).
	<b>or</b> press the hands-free/ open-listening key  .	Open-listening is switched on, persons present can listen in on the call (LED of the key  flashes).  <b>End open-listening:</b> Press the hands-free/ open-listening key  (LED of the key  is off).
You are telephoning over the headset, a second person listens in on the call over the handset. You want to switch of the headset.	Press the headset key  ( <b>long key press</b> ).	The headset is switched off (LED of the key  is off).

Situation:	Operation:	Result:
<p>You are telephoning over the handset, open-listening is switched on (LED of the key  flashes); you want to let another person listen in on the call over the headset.</p>	<p>Press the headset key .</p>	<p>Listening-in over the headset is now activated (LED of the key  flashes).</p> <p><b>End listening-in:</b> Press the headset key  (LED of the key  is off).</p> <p><b>End open-listening:</b> Press the hands-free/open-listening key  (LED of the key  is off).</p>
<p>You are telephoning over the headset, hands-free/open-listening is switched on (LED of the key  flashes). You want to switch of the headset.</p>	<p>Press the headset key  (<b>long key press</b>)</p> <p><b>or</b> press the hands-free/open-listening key  (<b>long key press</b>).</p>	<p>The headset is switched off (LED of the key  flashes; LED of the key  is off).</p> <p>The headset is switched off (LED of the key  is off). Hands-free/open-listening is switched on (LED of the key  is illuminated).</p>
<p>You are telephoning over the headset and want to end the call.</p>	<p>Press the headset key .</p>	<p>The connection is ended (LED of the key  is off).</p>
<p>You are telephoning over the headset, a second person listens in on the call over the handset. You want to end the call.</p>	<p>Press the headset key  (<b>short key press</b>).</p>	<p>The connection is ended (LED of the key  is off).</p>

Situation:	Operation:	Result:
<p>You are telephoning over the headset, hands-free/open-listening is switched on (LED of the key  flashes). You want to end the call.</p>	<p>Press the headset key  (<b>short key press</b>).</p>	<p>The connection is ended (LED of the key  is off; LED of the key  is off).</p>

### For the system administrator

You will find more information on connecting a headset and suitable devices in the “Mounting and Commissioning” (Forum 523/524, Forum 525/526, Forum 550/560, Forum 5004/5008/5012) resp. “Commissioning and Maintenance” (Forum 5500) guide in the chapter “Extensions and Accessories”.

**Note:** Connected headsets must conform with the standard DIN EN 60 950-1, Point 6.2 (“Safety of information technology equipment including electrical business equipment”). Please contact your customer consultant if you require further information about the connectable headsets, adapters and adapter cables.

# Telephoning

## In a hurry? A Brief Explanation of Important Functions

Please read this chapter in order to familiarise yourself with important telephone functions. It will only take you a few minutes.

### Talking on the Phone: Via the Call Key or the Handset

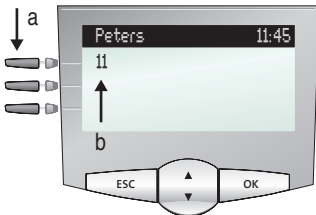

*Display Forum Phone 525:*

**a** Call key

**b** internal call number

Your telephone has at least one call key via which you can call or may be called. On the display, this key is labelled with the internal call number under which internal callers can reach you. The internal call number is allocated to an external call number under which you may be reached by external callers. Alternatively, the call key may have a text label. The system administrator may have set this up when the system was configured.

When you receive a call or call someone yourself, you have the following options for beginning to talk:



You pick up the handset.

or





You press the call key. You conduct the following telephone call in the hands-free mode.



or



You press the info key. You conduct the following telephone call in the hands-free mode.

Hands-free mode: The loudspeaker is turned on, you speak via the microphone in the handset while the handset remains placed in the telephone cradle.

If you have connected a headset to your telephone and activated it via the **4 Phone settings** MenuCard (see page 121), pressing the call key will turn on headset operation. The subsequent telephone call is conducted via the headset.

In the following explanations of this chapter, the  symbol means that you also have the option of pressing the call key  instead of picking up the handset.

**Tip:** You may have had more than one call key set up for you. The display shows each key labelled with the respective internal call number or with text. Usually you can use the telephone via each of these keys as described above. If these keys have been set up for you because you are a member of a team, you should read the chapter *Managing Calls in a Team* starting on page 98. It contains information on how to use the team functions set up for you on your telephone.

## Telephoning

### Do I need a code?

Depending on the system's configuration, you may have to enter a code (manual line seizure) or not (automatic line seizure) before entering an external call number. The system administrator will inform you what this code is (the default setting upon delivery is the code digit ). Internal call numbers are also entered differently for automatic or manual line seizure.

## Calling with manual line seizure (external with dialling code)

### Calling external parties



Enter the external line seizure code digit (e. g. ) and dial external call number.

### Calling internal parties



Dial the internal call number.

## Calling with automatic line seizure (external without dialling code)

### Calling external parties



Dial the external call number.

### Calling internal parties



Press the star key twice.



Dial the internal call number.

**Note:** Failure to obtain an external connection may be due to the system configuration. You either do not have the authorisation to dial external numbers or the desired external number is blocked.

## For the system administrator: system settings for dialling external call numbers

- External line seizure (automatic or manual) and authorisation for dialling external numbers (ranked according to local, national or international calls) can be defined in the **Configurator**, menu **User manager > User groups** (Settings: **External** and **Immediate External line seizure**).
- Blocked call numbers are managed in the **Configurator**, menu **Telephony > Lists > Black lists**.

## Redialling

The call numbers you have most recently dialled are stored in the redial list. To redial one of these call numbers, you have the following options:

### Redialling the last call number

 Press the redial key.

 Pick up the handset.

### Redial a particular call number in the redial list

 Press the redial key.

 Use the arrow key to select the number.

 Pick up the handset.

If a call number of the redial list is saved in the phone book and there are other call numbers (mobile call number, private number) saved in this phone book entry, use redial as follows:

 Press the redial key.

 Select an entry with the arrow key.

 Pick up the handset to call the office call number of this subscriber.

or:

 Press OK key. The additional call numbers of this subscriber are displayed in a MenuCard.

 Select **M**: (mobile call number) or **P**: (private call number).

 Pick up the handset to call the call number selected.

**Note:** If you initially called a person with suppressed call number (CLIR, also see the explanation in paragraph “*CLIR*” feature on page 56), your call number will also be suppressed when you call this person again from the redial list.

## Receiving Calls

When you receive a call, the LED next to the call key flashes. The  symbol appears in the display. The number of the person calling is shown (if the number is transmitted). If the telephone book of the Forum 500 / Forum 5000 has an entry for this call number, the name of the caller will be shown instead of their number.

### Accepting a call



Pick up the handset, conduct call.

### If you are already telephoning and receive another call



Press the call key.

The first caller will be placed on hold. You may now speak with the second caller.

To terminate the second call:



Press the disconnect key.



Press the call key where the first call is being held.



Now you may speak with the first caller again.

## Who Called?

The calls you receive are saved in the call list. Depending on your system configuration, external calls, internal calls, calls on busy, door calls or all calls are saved on this list. This list also shows you whether you have missed calls while you were away. You can query the call list and call the caller back.

### Missed calls

The LED of the info key  is flashing. To return a call:



Press the info key.



Use the arrow key to select the **3 Missed calls** menu entry.



Press the OK key.



Select the entry in the call list with the arrow key.



Pick up the handset.

### Calling a caller back

To call a caller on the call list:



Press the MenuCard key (long press).



Press the OK key (**1 Calls** is selected).



Press the OK key (**1 Call lists** is selected).



Press the OK key (**1 Missed calls** is selected).

or:

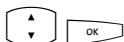

Use the arrow key to select **2 Accepted calls** and press the OK key.



Select the entry using the arrow key.



Pick up the handset.

### For the system administrator: system settings for the call list

The **Configurator, User manager > User groups** menu is where you define which calls are stored in the call list (settings: **manage external call list, manage internal call list, manage busy call list** and **manage door call list**). You can have calls where the call number was not transferred (e. g. because the caller suppressed the number) not included in the call list in the menu **Telephony > Settings (Call list: no entry if phone number missing setting)**.

## Querying/Toggling, Transferring

### Querying and toggling

During one call you may make another call: e. g. to obtain information:

#### To initiate a query



Press the R-key.



Dial the internal or external call number.  
The first caller is placed on hold and you now may speak with the second caller.

You may switch back and forth between calls, speaking alternatively with both callers. To alternate between callers (to **toggle**):



Press the R-key (repeat to toggle).

### To end query



Press the disconnect key.



Press the R-key.  
Now you may speak with the first caller again.

### Transferring a call to an internal subscriber

You may transfer a call to another internal subscriber with or without advance notice. To do this, you begin by initiating a query connection:



Press the R-key. The subscriber you were talking to before is put on hold.



Dial the internal call number.

If the internal subscriber answers:



Inform them that you are transferring a call and replace the handset in the telephone cradle

If the internal subscriber does not answer or is busy:



Replace the handset in the telephone cradle.

or:



Press the MenuCard key (short press).



Using the arrow key, select the **Transfer** menu entry.



Press the OK key.

The internal subscriber will be called. If he/she answers, he/she will be able to speak with the caller on hold. If he/she does not answer, you will automatically be called back after a certain length of time.

### Transferring a call to an external subscriber (transfer call)

You may also transfer calls to an external subscriber. The system administrator must provide you with the corresponding authorisation to do this, otherwise you will not be able to transfer calls in this way.



Press the R-key. The subscriber you were talking to before is put on hold.



Dial the external call number.



Press the MenuCard key (short press).



Using the arrow key, select the **Transfer** menu entry.



Press the OK key.

**Note:** When you call an external party and then transfer this person to another external party, you will bear the costs for the call between the two external callers. You have no way of influencing how long the transferred call will last. The connection is established via the Forum 500 / Forum 5000 and occupies two call channels.

### For the system administrator: system settings for transferring calls

- You can define the length of time after which a user trying to transfer a call is called back in the **Configurator**, menu **Telephony > Extended > Timer** (setting: **Timeout on calling**).
- External call transfer authorisation is set in the **Configurator**, menu **User manager > User groups** (setting: **External to external**).

## Audio: Muting, Open-Listening, Adjusting Telephone Volume

### Muting

While using the phone, you may switch off the microphone if you wish. The person you are speaking with will not be able to hear you:



Press the muting key.

Press it once again to switch the microphone back on.

### Enabling others to listen in



To allow others present to hear the telephone conversation, press the hands-free/open-listening key.

By switching on the loudspeaker, you may continue your call in hands-free mode.



Keeping the hands-free/open-listening key depressed, replace the handset in the telephone cradle. Then release the hands-free/open-listening key.

### Adjusting volume



To adjust volume during a call, use the plus/minus key:

- for handset volume
- or – if you're using a headset – for headset volume
- or – if you have the loudspeaker switched on – for loudspeaker volume.

This setting applies to the current call. To adjust volume permanently, please refer to the chapter *MenuCard "Phone Settings"* starting on page 121.



# General Functions

## Assignment of Internal and External Call Numbers

Your telephone's internal number is assigned when the system administrator configures the Forum 500 / Forum 5000 communications system. The call number is linked to the call key  of your telephone, which means you receive calls on this key. You can have several internal call numbers on different call keys on your system telephone. The external call number(s) at which you can be reached is (are) assigned to the call key(s) (with the internal number).

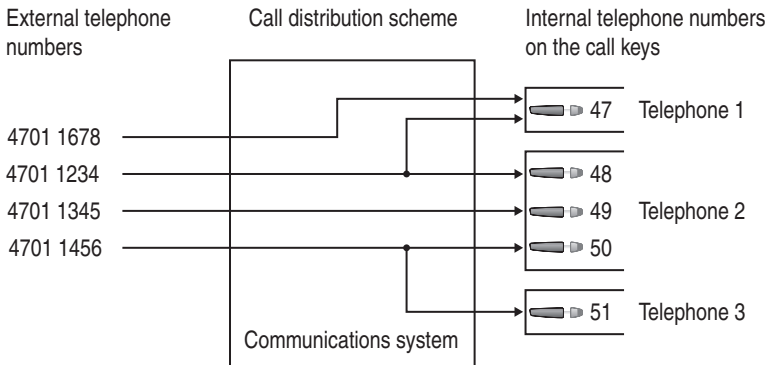

### Example of the assignment of internal and external call numbers

The above example shows that the system's external call numbers are first stored in the Forum 500 / Forum 5000. The telephones can be reached selectively by means of call distribution of the numbers to the internal numbers (call keys). As you see, telephone 1 and telephone 2 both ring when a call is made to the number 4701 1234. At the same time, telephone 1 can also be reached on the number 4701 1678.

## Signalling on the Call Keys

"Call key" is the general term for all keys of your telephone which you use to make calls and are called. These are feature keys (please refer to page 15 and page 16 also) or call keys with team functions (team keys or direct call keys, please refer to the chapter *Managing Calls in a Team* starting on page 98).

The LEDs and symbols on the call keys indicate the following states:

First call	LED flashes rapidly ☎ bell is displayed
Further call	LED flashes rapidly ☎ bell is displayed
Key seized	LED on ➤ arrow is displayed
Call held	LED flashes slowly ➤ arrow is displayed
Team member's key is seized	LED on ☎ handset and team key text are displayed

## Calls in the Call Waiting Queue

The system administrator can configure and activate a **call waiting queue** especially for your telephone in the Forum 500 / Forum 5000 system. While you are making a call, new calls can be queued. These callers first hear an announcement (if the system administrator has preset an announcement) and then the ring tone. The number of calls permitted in the call waiting queue is set by the system administrator during system configuration, 5 calls for example. When this number is reached, further callers hear the busy tone. The calls in the queue are put through in order of priority (baby calls, door calls, VIP calls, other internal and external calls), irrespective of the order in which they came in.

Calls that have been in the queue for too long are removed, and the callers then hear the busy tone. The period of time until an external call is released is set by the network operator. In most European countries this is usually three minutes.

Your telephone can have a call waiting queue even if it belongs to a subscriber group, where it simultaneously affects call forwarding.

If several call numbers are configured for your telephone (e. g. on trunk or team keys), separate call waiting queues are used for each number.

On the Forum Phone 535 incoming calls are signalled by means of a short tone (default setting); they are also indicated on the display. The system

administrator can switch off the notification tone for a new call in the web configurator with the **Beep for calls in call queue** option (menu: **Telephony > Devices > System phones**).

If there are calls in the queue, the level indicator appears at the beginning of the second line of the Forum Phone 535 display. If several call numbers with call waiting queues are configured for your telephone, the total number of entries appears.

### For the system administrator

The “Call Queue” chapter in the “Mounting and Commissioning” (Forum 523, Forum 525/526, Forum 550/560, Forum 5004/5008/5012) resp. “Commissioning and Maintenance” (Forum 5500) guide explains how to configure call waiting queues and set up an enquiry station using this function.



## Accepting a Call During Automatic Dialling

Sample situation: You have entered a call number or selected a call number (in the call list, the re-dial list or the phone book). The call number is not yet dialled and you receive a call at that moment. When you pick up the handset the following operations are possible:

- The call number you entered is dialled.
- You accept the call.

The **Prefer incoming connections** option determines which of these operations is carried out. The system administrator configures this option in the web configurator, in the **Telephony > Settings** menu.

## Block Dialling/Automatic Dialling

If you activate the menu item **5 En-bloc dialling** in the MenuCard **4 Phone settings**, you can enter all call numbers (and correct or add digits to them, if necessary) without lifting the handset (see *MenuCard “Phone Settings”* starting on page 121). The number is displayed in the info line. Entries from the redial list, the call list and the telephone book that are to be dialled using  also appear in the info line first. The number you have selected is not dialled until you lift the handset or press the hands-free/open-listening key .

If block dialling is switched off, the telephone switches to open-listening mode as soon as you enter a call number and dial it.

**Note:** An initiated automatic dialling is automatically terminated after 60 seconds if no further entries are made.

### **Block dialling and headset operation**

It is useful to activate the “block dialling” feature when using a headset (if you have activated this via the MenuCard **4 Phone settings**, see page 122). The call number entered will only be dialled once you have pressed the headset key .

Once block dialling has been activated and the headset switched on, the phone immediately switches over to headset operation and the call number is dialled when you enter a number on the phone.

### **Information about block dialling and CTI applications**

If you use CTI applications, you should **switch off** the “block dialling” function on your system telephone. This applies for all CTI applications, except for the application **Forum CTI**.

### **Automatic dialling for a different terminal**

You can use your system telephone for dialout for a different terminal (e.g. a DECT headset). To do so, save a destination call number on your system telephone (via the MenuCard **6 Connections**, the menu entry **2 Dial > 0 Remote dialling**, please refer to page 127 also). The saved call number will be dialled automatically when you press the headset key within 30 seconds. After 30 seconds, the dialout will be deactivated automatically.

This feature can be used for all devices for which the system administrator has configured a device ID. This means that you can also save a dialout for another user who, e. g. also has a system telephone.

### **For the system administrator**

Device IDs are set up in the **Configurator, Telephony > Extended > Device ID** menu. Authorisation for this feature is assigned in the **User manager > User groups** menu with the **Dial for other phone** setting.

## Muting

Pressing the muting key  deactivates the microphone during a call, and the person at the other end of the line can no longer hear you. Press the key again to switch the microphone back on.

## Call-charge Display, Duration Display

If your network operator transmits call-charge information, and if you have dialled an external number yourself, you will see the current amount of the charge in the info line during or at the end of a call. The menu item **6 Charge settings** in the **4 Phone settings** MenuCard lets you deactivate this or switch to the duration display (see also *MenuCard “Phone Settings”* starting on page 121).



## Adjusting the Volume with the Plus/Minus Key



Use the plus/minus key  to adjust

- the volume of the loudspeaker in hands-free/open-listening mode,
- the volume of the handset during a call via the handset
- or the volume of the headphone during a call via a headset.

When the telephone is in its idle state again, it reverts to the default menu setting. You can change the default setting using the **1 Volume** menu item in the **4 Phone settings** MenuCard (see also *MenuCard “Phone Settings”* starting on page 121).

When you receive a call, you can use the plus/minus key to adjust  ringing tone volume. This setting is stored immediately (even without pressing the  key) and will be active for all future calls.

## Redialling

Pressing the redial key  displays a MenuCard containing the last numbers dialled (with the most recent entry at the top). If a call number is also stored in your system's telephone book, you will see the name as well.

## Dialling a call number



Select the entry (phone number or name) and lift the handset. The call number will now be dialled automatically.

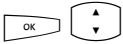

**Alternative:** If you *do not pick up* the handset and then press the OK key, you can execute the following functions:

- **Dial:** Press the OK key or pick up the handset. The phone number will be dialled.
- If there are other call numbers saved to the entry selected, these are offered for selection (**M:** = mobile call number) or **P:** = private call number).
- **Phone book:** You can add the entry to a telephone book (**1 New entry**) or to an existing entry (**2 Add**). Please see: *Add Phone Numbers to Telephone Book from Lists or during a Call* starting on page 89.
- **Info:** You can obtain information on the called subscriber (e. g. his or her phone number if his or her name is displayed in the redial list). You can see when you last dialled this number and how often you have tried to reach the subscriber. If there are multiple trunk keys configured on your telephone, the trunk key with which the call was made is indicated.

## Notes

- If your internal call number (e. g. “30”) is configured on more than one terminal, you can view and edit the redial list for the call number 30 on each of these terminals. If, for instance, you delete the redial list on one terminal, it will be deleted on all others as well.
- If you initially called a person with suppressed call number (CLIR, also see the explanation in paragraph “*CLIR*” feature on page 56), your call number will also be suppressed when you call this person again from the redial list.

## Hands-free Mode, Open-listening Mode

In hands-free mode, the handset stays on the hook. You hear the caller over the loudspeaker and speak through the microphone of the handset (although it is on the hook). Open-listening involves both, hearing the caller via handset as well as over the loudspeaker, so that other people present can listen in.

### Calling via the handset

To switch open-listening on/off, press the hands-free/open-listening key . To switch to hands-free mode, long press the hands-free/open-listening key and replace the handset. Then release the hands-free/open-listening key.

### Initiating a hands-free call

Instead of lifting the handset, press the hands-free key/open-listening . End the call by pressing the hands-free/open-listening key again.

## Blocked/Unblocked Call Numbers



Your telephone can be blocked from dialling all or selected external numbers. Emergency numbers can be entered in a special list, irrespective of your trunk line access rights, and so always be dialled. Consult your system administrator for details.

### For the system administrator

Blocked and unblocked call numbers are managed in the **Configurator**, menu **Telephony > Lists**.

## Telephone Lock

If you wish to permit another person to temporarily use your telephone, you can activate the telephone lock via the **5 Protection > 3 Telephone lock** menu entry (see page 124). Independent of the system configuration, when the telephone lock is activated, the functionality range is restricted on the telephone, incl. possibly restricted dialling rights.

When the telephone lock is activated, the LED of the info key  is illuminated while the info key is without function then. To deactivate the telephone lock, press the MenuCard key  and enter your user PIN thereafter.

## DTMF Postdial/VF Signalling

Depending on the system's configuration, your telephone is automatically set to VF (voice frequency) signalling in the connection state. You can use this, for example, to query an answering machine or a voice mailbox. Consult your system administrator if you have questions concerning this function.

## Keypad Dialling

A number of European network operators need the keypad protocol to set features. Depending on your system configuration your telephone could be set to keypad dialling during the connection state. If this is not the case, you must switch your telephone over to the keypad protocol – before dialling – and enter the code digits specified by the network operator. These are transmitted directly to the exchange and evaluated there. You usually get an announcement as an acknowledgement. Consult your system administrator if you have questions concerning this function.

### Switching to keypad dialling

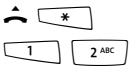

This switches your telephone over to the keypad protocol. You can now enter the code digits for the appropriate keypad.

**Note:** In the call state, keypad dialling is automatically active. Once the called subscriber answers the call, which could be an external answering machine for example, you can execute the required functions by pressing the number keys.

### For the system administrator

Authorisation for keypad dialling is set in the **Configurator**, menu **User manager > User groups** (setting: **Keypad dialling**).

## Least Cost Routing (LCR)

Whenever you make an external call, your system automatically uses LCR to set up a connection to a network operator that has been selected by the system administrator. If you do not wish to use this preferred connection and want to select a network operator yourself for each call (i.e. on a call-by-call basis), then before making the call, select the **LCR off** entry from the menu described in the section entitled *MenuCard "Selection" in the Idle State*.



This is only necessary if LCR has been configured for you in the Forum 500 / Forum 5000. Consult your system administrator about this.

**Note:** Baby call and external call forwarding are not automatically switched via preferred connections. In this case, if the network operator you wish to use is not the default operator, you can key in the appropriate operator's code digits before entering the call number.

## Transmission of Call Numbers

With ISDN there are different features which allow or prevent the transmission of (external) call numbers between subscribers.

### “CLIP” feature

“CLIP” is an abbreviation for “Calling Line Identification Presentation”. The caller's call number (if transmitted) is displayed by means of the corresponding call key. If this number is also stored in your telephone book, the caller's name is displayed.

### “CLIP no screening” feature

Using “CLIP no screening” outgoing connections instead of sending the real call number of the caller, send another call number. Thus, instead of being shown your number, the subscriber you have called is shown, for example, a service call number. The feature “CLIP no screening” must be enabled by the network provider and activated in the system configuration by the system administrator. When you receive an external call where the caller indicates a different number than the one actually being transmitted, your display will show a “?” next to the call number. If the indicated call number is saved as a phone book entry, as usual, the name will be shown along with a question mark.

**Note:** Display of the question mark “?” is the system default. The system administrator can switch off this default setting in the web configurator with the **Mark unchecked phone number with ?** option (**Telephony > Settings** menu).

### “CNIP” feature

“CNIP” is an abbreviation for “Calling Name Identification Presentation”. In addition to the call number, the name configured by the caller is also transmitted and displayed on the corresponding call key. If the caller's number

is listed in the Forum 500 / Forum 5000 telephone book, this local entry is displayed in preference.

### “CLIR” feature

“CLIR” is an abbreviation for “Calling Line Identification Restriction”. Before dialling a call number, you can decide from case to case if you wish to prevent your call number from being displayed to the called subscriber. To do this, select **Suppress number** from one of the MenuCards described in the next section. If this feature is not provided, your call number will always or never be displayed, depending on the system setting. Consult your system administrator for more information.

## MenuCards Before and During a Call



When your telephone is in the idle or the connection state, a short press of the MenuCard key provides you with state-dependent MenuCards displaying frequently used features you can activate.

### Example

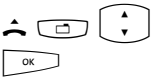

Another telephone in your pick-up group rings and you want to answer the call. Lift the handset, press the MenuCard key, select **Pick-up** and confirm this with the OK key.

Alternatively, let us assume the line you call is busy and you want the person with this number to call you back. When you hear the busy signal, press the MenuCard key and confirm **Callback** with the OK key.

The state-dependent MenuCards are illustrated at the end of each of the following sections.

**Note:** As a rule, the features are only available to you if they can actually be executed.

## MenuCard “Selection” in the Idle State

 **Briefly** press the MenuCard key (this also works if you have already lifted the handset), then select the following from the **Selection** MenuCard ...

**Unpark call:** Consecutively unparks one or more connections which you have previously parked, for instance to make enquiries or forward calls (see *MenuCard “Conversation”* starting on page 63). Select the parked call desired from the list offered. Confirm with the key .

**Pick-up:** Accepts a call for another telephone in your pick-up group.

**Pick-up select...:** Accepts a call for any other telephone. To do this, enter the call number of the other telephone. If the other telephone is already in the call state (e. g. an answering machine is in announcement mode), you pick up the call. The subscriber for whom you picked up the call must belong to a user group for which “Call removal” authorisation is activated, otherwise you will not be able to use the “Pick-up selective” function.

**Note:** If the called subscriber is a member of a user group for which pick-up protection is active, “Pick-up” and “Pick-up selective” are not possible.

**Take:** You accept a current call from a different terminal at your telephone and continue your call on your telephone. The prerequisite is that your telephone and the other terminal have the same internal call number. You can also programme the function “Take” to a feature key (see also *Programming Functions (Features)* starting on page 138).

**Announcement...:** After entering the call number, you can initiate an announcement to another system telephone, or on a group of system telephones.

**Intercom:** After entering the device ID, you can initiate an announcement to a **single** system terminal. The microphone is activated on the terminal called and the person you are calling can immediately answer your announcement. The “intercom” function cannot be used for announcements to a group of terminals.

**Charges:** For each trunk key, you can view the charges for the last call as well as the total charges.

**Door opener:** This activates the door opener.

**Notes:** Note a call number and a name or dial a noted call number.

**Suppress number:** For the following (external or internal) call, your call number will not be shown to the subscriber. This menu item is dependent on the system settings.

**Transmit number:** For the following call, your call number will be presented to the called subscriber. This menu item is dependent on the system settings.

**LCR off:** This switches off the LCR function.

**VIP call:** Your next internal call is made as a VIP call.

**Main menu:** This opens the Main menu; see the section entitled *Main Menu* starting on page 110. You can also open this menu by long pressing the MenuCard key.

## Making External/Internal Calls

### Manual or Automatic Line Seizure

If your telephone is set to **manual** line seizure, all trunk keys on your telephone first seize an internal line, and you can dial an internal number straight away. When making external calls, you must first press the line seizure code digit (presetting: ).

**Note:** This also applies to all enquiry calls and call forwarding to external destinations, but not to call forwarding “MSN”.

Your system administrator configures this code digit for all subscribers on the Forum 500 / Forum 5000 system and will tell you what value is currently valid.

If your telephone is set to **automatic** line seizure, all trunk keys on your telephone seize an external line, and you can dial external numbers straight away. In order to reach internal subscribers, press the star key twice   before dialling the internal number.

#### For the system administrator

- The code digit is defined in the **Configurator**, menu **Telephony > Trunks > Route** (Setting for the **External trunk** route).

- Immediate external line seizure is set in the user group by means of the **Immediate external line seizure** authorisation (in the **Configurator**, menu **User manager > User groups**).

## Making an External Call

### With automatic line seizure



Lift the handset (your call key is seized).

and/or



Press the particular call key (hands-free mode).

and/or



Press the headset key (headset operation requires that the headset is switched on, see page 122).



Dial the external call number.

### With manual line seizure



Lift the handset (your call key is seized).

and/or



Press the particular call key (hands-free mode).

and/or



Press the headset key (headset operation requires that the headset is switched on, see page 122).



Dial the line seizure code digit (presetting: ) and then the external call number.

## Making an Internal Call

### With automatic line seizure



Lift the handset (your call key is seized).

and/or



Press the particular call key (hands-free mode).

and/or



Press the headset key (headset operation requires that the headset is switched on, see page 122).



Press the star key twice.



Dial the internal call number.

### With manual line seizure



Lift the handset (your call key is seized).

and/or



Press the particular call key (hands-free mode).

and/or



Press the headset key (headset operation requires that the headset is switched on, see page 122).



Dial the internal call number.

## Using Destination Keys to Make Calls



You can save call numbers to programmable keys. To dial, simply press the destination key.



Then you pick up the handset or press the desired call key, hands-free/open-listening key or headset key. Your call key is seized.

### Behaviour of the destination key in call state

Programming the destination key determines what function the destination key has while you are making a call. The following functions are possible:

- After pressing the key, an enquiry call is established with the stored call number. The enquiry key must not be pressed beforehand.

This function is programmed with the setting **Action during conversation > Consultation**.

- After pressing the key, the numerical sequence stored for the key in question is transmitted as DTMF tones.

This function is programmed with the setting **Action during conversation > DTMF**.

## Call Waiting with an Internal Subscriber

When you call an internal subscriber whose number is busy, your call will appear on their display and signalled with the call waiting tone (exception: hunt groups to a busy comfort hunt group are not signalled with a call waiting tone). You hear the ringing tone yourself. The system administrator can determine that a special ringing tone is used for call-waiting calls. Based on this special ringing tone, you can decide whether you wish to end the connection or not.

If the subscriber called has activated call-waiting protection (see page 124) you will hear the busy signal. You can penetrate a subscriber's call-waiting protection via a VIP call (see page 66).

## Using Routes to Make Calls



Enter the routing code and dial the call number.

For enquiry calls:



Enter the routing code and dial the call number.

The Forum 500 / Forum 5000 sets up calls to the desired subscribers either automatically or via specific routes. Your system administrator configures these routes in the Forum 500 / Forum 5000 and specifies how each route is seized. To manually seize a specific route for a call, you dial the routing code before dialling the (internal or external) call number. Making calls via specific routes enables you to contact subscribers in the branches of a large company network, for example. You can also use a manually-entered routing code to record your call-charge data for private and business external calls separately.

The **default route** “External line” is always present and cannot be deleted. Automatic line seizure uses the Forum 500 / Forum 5000 line seizure code digit for the default route.

For information on the current routes and their codes, please contact your system administrator.

## Busy Display for Bundles and Routes on the System Telephone

The system telephones can display whether all lines (trunks) of a bundle or a route are busy.

To do this, you must programme a feature key (function key) for the system telephone in the **Configurator** (in the **Telephony > Devices > System phones** menu, function “Bundle state” or “Route state”). This function cannot be programmed on the system telephone itself. Contact your system administrator if necessary so that this feature key can be configured for you.

The name of the bundle or route and the number of busy channels appear in the display. This display is constantly refreshed.

If the “Route state” function is programmed and you press this programmed key briefly, the routing code will be dialled accordingly (e. g. “0”).



If all lines in the bundle or the route are busy, the LED on the programmed feature key is illuminated.

## Ending Calls

To end a call



Replace the handset or



press the disconnect key.



In hands-free mode, by pressing the hands-free/  
open-listening key.



During headset operation, by pressing the headset key.

If the person you are speaking to ends the call while you are in hands-free mode, the busy tone for your telephone is switched off after a few seconds and you can be reached again. This also applies if you were connected to the other subscriber via your headset. The period of time after which the busy tone is switched off is configured by the system administrator. All other calls will be ended after 20 seconds if the handset is off the hook.

## MenuCard “Conversation”

 Briefly press the MenuCard key, then select the following from the **Conversation** MenuCard ...

**Phone Book:** You can add the other party’s phone number to a telephone book as a new entry (**1 New entry**) or you can add it to an existing entry (**2 Add**). Please see: *Add Phone Numbers to Telephone Book from Lists or during a Call* starting on page 89.

**Booking Number:** You can use a booking number to record the call data of connections to external subscribers and save it in the Forum 500 / Forum 5000 for further analysis. Booking numbers are useful, for example, for calculating costs per client (fees and times) in an office. Select the menu item. Under **No.** enter the booking number (8 digits maximum) and confirm your entry with the  key. For further details please refer to the section entitled *Hints on booking numbers* starting on page 65.

**Park call:** Users can “park” one or more callers to make other calls or put down the handset and engage in other activities. (This is fundamentally different from the “Hold Connection” function; with this function the connection to the caller is terminated when the called subscriber puts down the handset). Parked calls are recorded in a list on the system terminal. The system offers the next available parking spot (0-9, \* or #). Users can accept the calls from the list in whichever order they wish, enabling them to “unpark” specific calls as required. Until his call is “unparked”, the caller will hear music on hold, provided music on hold has been configured. If the user does not “unpark” the caller after a certain amount of time, he will receive an automatic recall if the handset has been replaced (the display shows information on the recall). This automatically “unparks” the caller. If, however, the user is still making another call and has not hung up, the caller will hear the busy tone and will be “unparked”.

Authorisation for parking connections and the period of time after which there is a recall is defined by the administrator during the configuration of the system.

**Pick-up\*:** Accepts a call for another telephone in your pick-up group. Your first call is put on hold.

(\*: Not possible if there are already two active calls.)

**Note:** If a called subscriber is a member of a user group for which pick-up protection is active, then you cannot pick up calls to that subscriber’s number.

**Pick-up select...\*:** You accept a call for any other telephone. To do this, enter the number of that telephone. If the other terminal is already in the call state (e. g. an answering machine is in announcement mode), you pick up the call. The subscriber for whom you picked up the call must belong to a user group for which “Call removal” authorisation is activated, otherwise “Pick-up selective” is not possible.

(\*: Not possible if there are already two active calls.)

**Note:** If a called subscriber is a member of a user group for which pick-up protection is active, then you cannot selectively pick up calls to that subscriber’s number.

**Take:** You accept a current call from a different terminal at your telephone and continue your call on your telephone. The prerequisite is that your telephone and the other terminal have the same internal call number. Your first call is put on hold. You can also programme the function “Take” to a

feature key (see also *Programming Functions (Features)* starting on page 138).

**Hold:** The subscriber is put on hold. If you are member of a team, this call may be picked up by another member of your team (see also the section *Holding and transferring calls with a feature key* starting on page 101).

**Door opener:** This activates the door opener.

**Notes:** You can note a call number during a call. Under **Dest.**, enter the number and a **Text**, if required, and **Save** the number. Later, you can then call the number with **Dial**.

**Call recording:** You start a call recording session. You will only see this menu entry if the system administrator has enabled the function “Call recording” for you (also see chapter *Call Recording* starting on page 82).

**Intercept:** The call numbers of “malicious callers” can be saved in your network operator’s exchange (if this service is enabled). The function is also possible if the caller has already hung up!

### Hints on booking numbers

- Entering a booking number during a call is possible only if the system administrator has activated this function for your user group. Only then will the **Booking number** menu item be displayed.
- For external connections established by you it is important how the route that you are using for the connection has been configured by the system administrator. Among other things, the system administrator specifies whether a booking number is entered through the system terminal menu (and therefore during a call). He can, however, also specify that booking numbers must be entered with a code procedure. In that case the booking number must be entered before the call is initiated and the connection is made. It is entered after the routing code and before the actual destination number. In this case it is not possible to enter the booking number during the call.
- You can also programme the function “Enter booking number” to a feature key (see also *Programming Functions (Features)* starting on page 138). Via this feature key you can then enter the booking number during the conversion. To programme, select the **6 Connections > 2 Dial > 9 Booking number** entry from the **Main menu**. You can define a booking number that will be saved to the feature key. If you do not define a booking number,

then you can – after pressing the feature key – enter “any” booking number. Ask your system administrator how long a booking number can be (this depends on the system configuration) and which booking numbers already exist, if any.

- Calls made with booking numbers can be analysed with the Forum 500 / Forum 5000’s **Forum Count** web application.

## MenuCard “Busy”

 **Briefly** press the MenuCard key, then select the following from the **Busy** MenuCard ...

**Callback:** You leave your callback request with a busy internal subscriber (not possible for hunt group numbers).

**Pick-up select...\*:** You accept a call for any other telephone. To do this, enter the number of that telephone. If the other telephone is already in the call state (e. g. an answering machine is in announcement mode), you pick up the call. The subscriber for whom you picked up the call must belong to a user group for which “Call removal” authorisation is activated, otherwise “Pick-up selective” is not possible.

(\*: Not possible if there are already two active calls.)

**Note:** If a called subscriber is a member of a user group for which pick-up protection is active, then you cannot selectively pick up calls to this subscriber’s number.

**VIP call\*:** Your call is acoustically signalled to called internal busy subscribers, even if they have activated their call waiting protection, call protection or call forwarding (only possible on system terminals).

(\*: Not possible if there are already two active calls.)

# Accepting Calls

## By Lifting the Handset or Pressing a Key

### Normal call



Lift the handset.

or



Press the info key (hands-free mode).

or



Press the call key to which the call is being signalled (hands-free mode).

Lifting the handset always accepts the caller who has been waiting the longest (note the bell symbol 📞 in the display, see also page 47).

### VIP call

Calls of this type from authorised subscribers are signalled to you even if you have activated your call waiting protection, call protection or call forwarding. You hear the ringing tone:



Lift the handset.

or



Press the info key (hands-free mode).

or



Press the appropriate call key (hands-free mode).

### Call for a virtual number (Tele Secretary)

In the Forum 500 / Forum 5000, numbers can be configured to which no telephone and no subscriber are assigned (virtual numbers). The system administrator can forward a virtual number to another internal number, the number of your telephone for example.

A forwarded call is signalled on the corresponding call key of your telephone. For informational purposes the virtual number to which the call was originally made is shown. The system administrator can also assign the virtual number a name. If this has been done, the name is shown on the display of your telephone.



Lift the handset.

or



Press the info key (hands-free mode).

or



Press the call key to which the call is being signalled (hands-free mode).

### External calls with unknown call number

When you receive an external call where the caller indicates a different number than the one actually being transmitted (CLIP no screening), your display will show a “?” next to the call number. If the indicated call number is saved as a phone book entry, as usual, the name will be shown along with a question mark. Note: Display of the “?” can be deactivated by the system administrator.

## Automatic Call Connection

In certain operational modes (e.g. in hands-free operation or when making calls with a headset), it can be useful to be able to accept subsequent calls automatically. On your system telephone, you set the delay and the call type (internal/external) after which calls are automatically connected in the **5 Auto call Answer.** sub-menu of the **1 Calls** menu.

## Calls During a Conversation

### On the same call key



You are speaking on the telephone, hear the call waiting tone and see the call on your display.



Press the call key assigned to the line on which you are speaking. This puts your first call on hold and connects you to the new caller.



Press the disconnect key to end the current call.



Press the call key again.



You are now reconnected to the subscriber you put on hold.

### On a different call key



You are conducting a call, hear a notification tone (default) and see the call on the display.



Press the flashing call key. This puts your first call on hold and connects you to the new caller.



Press the disconnect key to end the current call.



Then press the call key of the held subscriber. (The LED of the call key flashes and the arrow symbol  is displayed.)



You are now reconnected to the first subscriber.

### Note:

The system administrator can switch off the notification tone for a call on another call key in the web configurator with the **Beep for calls in call queue** option (menu: **Telephony > Devices > System phones**).

### VIP call



You hear the call waiting tone. During a call, press the call key that signals the call.

## MenuCard “Call Waiting”

 You hear the call waiting tone. **Briefly** press the MenuCard key, then select the following from the **Call Waiting** MenuCard ...

**Accept:** You accept the waiting call. The person you were talking to before is put on hold.

**Reject:** The caller hears a busy tone.

**Deflect:** You do not accept the waiting call, but deflect it to another subscriber after entering this subscriber’s call number as the destination (**Dest.**). You can only use the “Deflect call” function if your user group is authorised to forward calls to internal and/or external destinations.

## MenuCard “Call”

 **Briefly** press the MenuCard key, then select the following from the **Call** MenuCard ...

**Reject call:** You reject the call. The caller hears a busy signal.

**Deflect call:** You do not accept the call yourself, but deflect it to another subscriber after entering this subscriber’s call number as the destination (**Dest.**). You can only use the “Deflect call” function if your user group is authorised to forward calls to internal and/ or external destinations.

**Door opener:** This activates the door opener.

## Voicebox Queries

There are various ways of listening to the messages in your voicebox:

- via **Forum Voicemail** (from a telephone whose number is not assigned to your voicebox)
- by calling the voicebox directly (from a telephone whose number is assigned to your voicebox)
- by means of the additional menu **9 Applications** in the Main menu (see the section entitled *MenuCard “Applications”* on page 133).

**Note:** For detailed information on the operation of **Forum Voicemail**, please refer to the user guide of the add-on component “Forum Voicemail”.



# Enquiry, Toggling, Transfer and Conference

## Enquiry/Toggling by means of the R-Key or Another Call Key



During a call, press the R-key (display in the info line) and:



Dial the internal or external call number (for manually-seized trunk calls with the line seizure code digit, e. g. , see page 58).

or:



Press another call key to place an enquiry call with a team member.

The original call is put on hold while you are consulting with the third person.



To toggle (i.e. switch backwards and forwards between the two calls), press the key of the held subscriber (the LED of this call key flashes and the arrow symbol  is displayed).



End enquiry/toggling by replacing the handset or pressing the disconnect key.

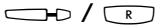

Then press the key of the call on hold.



You are now reconnected to the caller who was on hold.

## Transferring an Internal/External Call to an Internal Subscriber

You have dialled an internal enquiry call (see the section entitled *Enquiry/Toggling by means of the R-Key or Another Call Key* on page 71).



When the subscriber answers, inform them of the call transfer and hang up.



If the other subscriber does not answer or is busy, replace the handset, the other subscriber is called.

If the called internal subscriber answers, they are connected to the waiting call. If this call is not accepted within a certain period of time (by default 45 seconds), you are called back and, after lifting your handset or pressing the call key, are reconnected to the original subscriber and the display shows information on the recall.

The period of time after which a recall is made can be changed on the Forum 500 / Forum 5000 by your system administrator. Ask your administrator what the current time is.

While a call is being transferred to another internal subscriber, the caller hears music on hold. The setting **Music on hold upon transfer on calling** in the **Configurator** of the Web console specifies whether callers continue to hear music on hold on recall, or whether they hear the ring tone again.

Use the following procedure to disconnect an enquiry connection (e. g. when the subscriber called is busy):



Press the disconnect key and then press

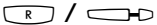

the enquiry key or the call key on which the subscriber with whom you originally spoke is waiting.

## Transferring an External Call to an External Subscriber

An external call can only be transferred to an external subscriber by means of the MenuCard **Subscr on hold**.



To do this, **briefly** press the MenuCard key.



Select the **Transfer** menu item.



Confirm with the OK key.

**Note:** When you call an external number and then transfer this person to another external party, you will bear the costs for the call between these two external callers. You have no way of influencing how long the transferred call will last. The connection is established via the Forum 500 / Forum 5000 and occupies two call channels.

## MenuCard “Subscr (Subscriber) on hold”

 You are making an internal or external enquiry call ...

 Briefly press the MenuCard key, then select the following from the **Subscr on hold** MenuCard ...

**Transfer:** You connect the subscriber on hold to the subscriber with whom you are currently speaking.

**Conference:** This initiates a three-party conference.

**Toggle:** This function enables you to switch between the subscriber with whom you are currently speaking, and the one with whom you last spoke.

**Park call:** You can “park” one or more calls and make other phone calls in the meantime (see *MenuCard “Conversation”* starting on page 63). The system offers the next available parking spot (0-9, \* or #). Confirm with the key .

**Door opener:** This activates the door opener.

## Internal/External Three-Party Conference

You have dialled an internal or external enquiry call (see the section entitled *Enquiry/Toggling by means of the R-Key or Another Call Key* starting on page 71).



If the subscriber answers, inform them of the conference and



select the **Conference** menu item from the MenuCard **Subscr on hold**. The conference is started.



End the conference by hanging up or pressing the disconnect key.

**Note:** Interconnecting the two conference subscribers or removing one of them from the conference is only possible using the appropriate menu item in the MenuCard. 3-party conference connections are not available.

If you wish to speak to one of the conference subscribers separately again or remove one of them,



Press this subscriber's call key. You are now speaking with this subscriber, while the other subscriber is on hold. Now you can toggle again.



End your conversation with this subscriber by pressing the disconnect key and



Then press the call key of the subscriber on hold.

## MenuCard “Conference”

 Briefly press the MenuCard key, then select the following from the Conference MenuCard ...

**Disconnect: 34565483:** This removes an external subscriber from the conference.

**Disconnect: 1234:** This removes an internal subscriber from the conference.

**Transfer:** This removes you from the conference, while the two other subscribers remain connected.

**End conference:** This ends the conference.



**Toggle:** This breaks up the conference and you can now switch between the subscribers.

**Door opener:** This activates the door opener.

# Special Calls/Functions



## Accepting an Appointment Call

You can save appointments with the menu item **3 Appointments** in the MenuCard **3 Messages**.

At the appropriate time, the appointment message appears on the display and your telephone rings for one minute with the ringer volume steadily increasing. Press the OK key  once to switch the ringer signal off. Press  again to acknowledge the display signal. If you lift the handset during an appointment call, a special tone indicates that the ringer signal was an appointment call.

You can also end the appointment call with the  key or by lifting the handset. Elapsed and active appointment calls are displayed in the **Info** MenuCard.

## Baby Call

You can save an internal or external call number in the menu item **4 Baby call** of the MenuCard **5 Protection**. If the menu item has been activated, this programmed call number is dialled when a specified period has expired (default setting is five seconds after you have lifted the handset). If you begin dialling a call number within the specified period, the baby call is cancelled. The baby call can also be triggered by pressing the hands-free/open-listening key , a call key  or the headset key  (requirement: the headset has to be turned on, see page 122).

Your system administrator configures the baby call period from 0 to 20 seconds for all subscribers on the Forum 500 / Forum 5000. Ask your administrator what the current value is.

## Announcements (with and without Intercom)

Announcements can only be made to system terminals. For you to be able to use this function, the system administrator must set up the corresponding authorisation for you. Announcements can be set up on single or multiple system terminals. The “Announcement” function is available in two versions.

- **Announcement with intercom:** the microphone of the terminal called is switched on and the person you are calling can immediately answer your

announcement (hands-free mode). An announcement with intercom can only be conducted to a single system terminal (not a group of terminals).

- **Announcement without intercom:** The called subscriber hears a special information tone followed by your announcement. In order to answer your announcement, the subscriber has to take the call just like a normal call (please refer to the section *Responding to an announcement* on page 77 also).

If you make an announcement to a group of system telephones (e. g. to a hunt group number on which calls are signalled simultaneously), all subscribers called hear the announcement at the same time. You hear a signal tone via your telephone when the (announcement) connection has been made to all called subscribers. If one of these subscribers replies to the announcement (by accepting the call), the announcement call to the other system terminals is terminated.

If a subscriber being called has activated announcement protection or intercom protection, announcements to that subscriber's call number will not be carried out.

### Making an announcement without intercom



**Briefly** press the MenuCard key and



select **Announcement**.



Under **Dest.:** you enter the call number (of a single terminal or of a group of terminals).

Make your announcement.

### Making an announcement with intercom



**Briefly** press the MenuCard key and



select **Intercom**.



Under **Device-ID:** you enter the device-ID of the terminal. Your system administrator can provide you with the device ID.

Make your announcement.

## Responding to an announcement

If you receive an announcement yourself, you will hear a special information tone.

### For an announcement without intercom

That function requires that your user group has to have “Announcement accept” authorisation granted by your system administrator.



To respond, lift the handset or press the hands-free/open-listening key.

or:



Press the headset key (requirement for headset operation: headset must be activated, see page 122).

or:



**Briefly** press the MenuCard key.



Select **Accept** in the MenuCard **Announcement**.

### For an announcement with intercom

Your telephone switches to the hands-free mode when it receives the announcement. You can speak with the caller immediately.

**Note:** When you have activated announcement protection (see page 123) and/or intercom protection (see page 125) on your system telephone, announcements to your call number will not be carried out.

## Rejecting an announcement



In the MenuCard **Announcement**, select **Reject** if you want to reject the announcement call. The subscriber making the announcement then hears the busy tone.

or:

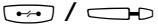

You can also reject the announcement by pressing the disconnect key or a feature key on which you have programmed the **Reject** function.

or:



You can also reject an announcement call with **Announcement with intercom** by pressing the hands-free/ open-listening key or – if you are using a headset – press the headset key (requirement for headset operation: headset must be activated, see page 122).

## Answering a Callback

A callback request is carried out when the other subscriber is free again.



When you hear the signal on your telephone, lift the handset.

The other subscriber will be called.

## Forwarding Calls

### Types of forwarding

You can forward internal or external calls intended for yourself to another internal call number or, provided that you have the necessary user group authorisation, to another external call number. Calls can be forwarded either immediately, after a specified period of time (delay) or if the line is busy. You can configure more than one call forwarding mode at the same time (**Immediately**, **After delay** or **Busy**). You can, for example, configure call forwarding **Immediately** for external calls to one call number, and call forwarding **After delay** for internal calls to a different call number. During configuration, the system administrator defines an interval in seconds for **After delay** call forwarding. You can replace this default with your own individual value when programming **After delay** call forwarding. If more than one forwarding mode has been activated, **Immediately** is given priority.

### Call forwarding to a voicebox

If **Forum Voicemail**, the integrated voicemail system, is installed in the communications system, you can also forward your calls to a voicebox configured for you.



### Call forwarding instances set up by the system administrator

- **Selective Call Forwarding:** The system administrator can programme call forwarding where the call number of the caller is analysed (“SCF: Selective Call Forwarding”).
- **Call filter:** The system administrator can use call filters to establish call forwarding settings that apply to callers with specific call numbers or callers with suppressed numbers.

Potentially this could be the reason why specific calls do not reach you. If you have any questions concerning this functionality, please consult your system administrator.

### Least Cost Routing

Least Cost Routing (LCR) can be evaluated with call forwarding to external numbers, provided your system administrator has configured LCR and its application in the Forum 500 / Forum 5000 correspondingly. Ask your administrator for the configuration applicable to you.

### Hunt group call numbers

During system configuration, the system administrator can configure call forwarding destinations for standard and comfort hunt group call numbers. These destinations are called if all members of a standard or comfort hunt group are busy or if (for a standard hunt group of type **Linear**, **Cyclical** or **Statistical**) the call is not picked up by any group members within a certain period of time. You cannot view or change this call forwarding on your device.

In addition, the system administrator can determine whether you can forward incoming **standard** hunt group calls or not. If the system administrator does not permit call forwarding for your standard hunt group call number, any call forwarding that you have programmed on your device is not carried out upon a hunt group call.

For more information on the topic of standard and comfort hunt groups, please contact your system administrator.

### Call forwarding chains

The system administrator can configure the system so multiple call forwarding instances can be linked one to another to form a chain. A simple example: user A forwards to user B, who then forwards to user C. A call for user A is then directly signalled to user C.

A setting in your user group regulates which call number appears on your

device when a call which has been forwarded multiple times is signalled on your device: you will see either the call number of the last user who programmed the last call forwarding in the chain, or the call number of the first user in the chain. The number displayed is also saved to the caller list for missed calls.

The system prevents call forwarding chains from forming a loop, e. g. when the call forwarding destination refers back to the call forwarding source. When the system detects a call forwarding loop, no further call forwarding is carried out. This can mean that – despite call forwarding being programmed – calls are nonetheless signalled on your device.

A loop is also detected during call deflection. If you receive a call via a call forwarding chain and wish to deflect it to a destination call number which is already in the call forwarding chain, a negative acknowledgement tone is heard and the call signalling on your device will continue.

Contact your system administrator if call forwarding is not functioning as expected on your device. The system administrator is able to analyse call forwarding chains and eliminate any possible conflicts.

## Caller History

### Function description

The caller history is a list in which the call numbers of external callers and their internal contacts are saved. If you are called by one of these external call numbers, you can use the caller history to see who the caller was connected to on their last call. You can also re-connect the caller to an internal contact that they have already spoken to in a previous call. This function may be useful for switchboards, for example. Each entry in the caller history consists of the following information:

- Date and time of the connection
- Call number of the external caller (CLIP)
- Call number of the internal subscriber with whom the caller has spoken If the caller is transferred several times, only the call number of their **last** internal contact is stored.

**All** external calls that have been accepted by users of the communications system are stored in the caller history. If the communications system is used

by several companies at the same time, you only have access to the list entries relevant to your company, and not those of other companies.

### Prerequisites

In order for you to be able to use the caller history function, the system administrator needs to make sure the following prerequisites are met:

- A **Caller history** function key must be programmed on your telephone (in the **Configurator**, menu **Telephony > Devices > System phones**).
- The **Caller history** authorisation must be activated for your user group (in the **Configurator**, menu **User manager > User groups**).

### Operating the function

In idle mode, the function key is labelled with the text that was entered when the key was programmed (e.g. **Caller history**).

When you receive an external call, the communications system checks whether there is an existing entry in the caller history for the external call number in question. If an entry already exists, the function key will display which internal subscriber the caller was (last) connected to during their last call.

### Immediately transferring callers



The call is signalled on your telephone (call status). The LED for the key flashes.

If you press the function key, the caller is transferred directly to the (last) internal subscriber that they spoke to on their last call. The call is not picked up on your system.

### Connecting callers to a previous contact



You have picked up the call (call state). The LED for the key illuminates.

If you press the function key, the list of calls for this caller is opened (max. 10 list entries). Details of which internal subscriber the caller (last) spoke to in the relevant telephone call is displayed for each call.

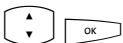

Select the relevant entry and press the OK key. The caller is connected to the relevant internal subscriber.

### Further information

For further information about the caller history or if you have questions about your authorisation, contact the system administrator.

## Call Recording

You can record internal and external calls, e. g. for logging purposes.

### Features of this function

- The “Record calls” functions is only available on the Forum 5004/5008/5012 and Forum 5500 communications systems.
- Three-party conferences cannot be recorded.
- Messages that are stored in your voicebox cannot be recorded either.
- Recorded calls are stored in your voicebox, together with your voicebox messages. The total capacity for all recordings **and** messages (of all users) is 24 hours in a Forum 5500 communications system, and 6 or 24 hours (with an additional memory module installed) in a Forum 5004/5008/5012 communications system.
- The recordings are stored in a separate list. You can display this list from the main menu (see also the chapter *MenuCard “Calls”* starting on page 112). In addition, you can view and edit the recordings list through the web application **Forum CTI**.

### Prerequisites

In order for you to be able to record calls, the system administrator needs to make sure the following prerequisites are met.

- He has to set up a voicebox for you (i.e. for the call number of your terminal) (in the **Configurator**, menu **Applications > Forum Voicemail > Voice Boxes**).
- The authorisation **Call record** has to be activated for your user group (in the **Configurator**, menu **User manager > User groups**).

### Important privacy note

For privacy protection reasons it may be required to announce the start of a call recording session with a beep. The administrator has to activate the authorisation **Call record with beep** for your user group (in the **Configurator**, menu **User manager > User groups**).

## Operating the function on a system telephone

The “Call recording” function can be operated on the system telephone by means of a programmed function key or via the status-dependent MenuCard **Conversation**.

- For programming the function key, select the **6 Connections** entry on the **Main menu** MenuCard: **4 Call > 0 Call recording** off. For more information, please refer to the *Programming Functions (Features)* starting on page 138 chapter.
- See the MenuCard “*Conversation*” starting on page 63 chapter, for more information on status-dependent menus.

## Starting and stopping call recording (with a programmed function key)

You are in a telephone call.

### Start recording



Press the function key. When the recording is session is started, the LED of the key lights up. The LED is on during the entire recording session.

If the communications system is configured accordingly, it produces a beep when the recording session starts.

### End recording



Press the function key again. The LED is switched off.

## Starting and stopping recording (via the “Conversation” MenuCard )

You are in a telephone call.

### Start recording



**Briefly** press the MenuCard key. The **Conversation** MenuCard is displayed.



**Select Call recording**, press OK.

If the communications system is configured accordingly, it produces a beep when the recording session starts.

## End recording



Press the function key again. The **Conversation MenuCard** is displayed.



**Select Call recording**, press OK.

## Notes

- Call recording automatically ends if:
  - the caller who started the recording session establishes an enquiry connection,
  - the recording memory is full or
  - the connection is terminated.
- A call can only be recorded by one of the two callers. If one of the callers has started recording the call, the other caller cannot simultaneously record the call himself.
- If a call cannot be recorded, the communications system produces a negative acknowledgement tone.
- If a call could not be recorded, the communications system will send you a short message. Refer to the *MenuCard “Info”* starting on page 134 chapter for more information on reading short messages.

## Automatic Call Recording

Depending on the system configuration, the communications system can automatically record and save your calls with **external** subscribers.

### Features of this function

- The “automatic call recording” function is only available with the Forum 5004/5008/5012 and Forum 5500 communications systems.
- Only calls with **external** parties are recorded. This applies to both incoming and outgoing calls that are made directly to you or made by you, as well as calls that are forwarded to you.
- In principle, only the parts of a connection in which **two** subscribers are talking to one another are recorded. In any situation where there is a connection but you are not talking to the external party (e.g. in the event of an enquiry call or if you have started a 3-party conference), recording is automatically stopped for this call segment. Recording restarts as soon as

you speak with the external party again (e.g. once you have finished the enquiry call).

- The communications system saves each recorded call segment in an audio file. Access to these audio files is reserved for the system administrator.
- As soon as the connection to the external party is terminated, call recording is ended.

### Note on data protection

You must inform the external party that the call is being automatically recorded.

### Operating the function on a system telephone

The system administrator can configure a function key for automatic call recording on your system telephone. The LED of this function key lights up when the current call is being recorded.

If you have the relevant authorisation, you can cancel the recording by pressing the function key (LED is switched off). If you cancel the recording, the entire recording of the call segment in which you participated is discarded.

The LED switches off automatically if recording is not currently possible (e.g. because the required recording memory is full). In this case, inform the system administrator.

### Further information

For further information about automatic call recording or if you have questions about your authorisation, contact the system administrator.

## Doorbell, Door Opener

A doorbell is signalled to your call key and appears in the display. If the call number of the door has its own phone book entry, or the system administrator assigned a name when the doorbell was configured, the name of the doorbell is displayed.

### Opening the door while the handset is on hook



Lift the handset.



Press the MenuCard key.



To open the door, select the **Door opener** menu item in the MenuCard displayed.

### Opening the door during a call



If the doorbell signal is triggered during a call, you will hear the call waiting tone.



Press the call key to which the door call is being signalled. This puts your first call on hold and connects you to the visitor at the door.



Press the MenuCard key.



To open the door, select the **Door opener** menu item in the MenuCard displayed.



Press the call key again.



You are now reconnected to the subscriber you put on hold.

## Entrance Intercom Calls

### Calling the entrance intercom

If an analogue entrance intercom (e. g. of the “Doorphone” type) or a SIP entrance intercom is connected to your system, you can use this procedure to speak with a visitor.



In an enquiry call:

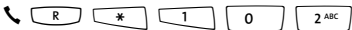

The code procedure for calling the door intercom is determined by the system administrator. Possible codes are:



Contact your system administrator regarding the valid code procedure.

Alternative: You can also call the door intercom by selecting the **6 Connections > 8 Door call** entry from the **Main menu** (see page 130).



**Signal when the handset is on hook**

☒ Lift the handset.

- If your system is connected to an entrance intercom, you can speak to your visitor.
- Otherwise you will hear a special door tone when you lift the handset.

**Signal during a call**

☒ If the doorbell signal is triggered during a call, you hear a call waiting tone. Proceed as described in the chapter *Doorbell, Door Opener*, section *Opening the door during a call* starting on page 86.

**Door call forwarding**

You can forward calls signalled from the doorbell to another (internal or external) call number, a so-called “pharmacy line”. This is done through the **2 Call forwarding** menu (see the section entitled *MenuCard “Call Forwarding”* starting on page 117).

**Call duration**

All door calls are automatically terminated after a specific period has expired. This ensures that forwarded door calls do not unintentionally lead to continuous calls (e. g. to a mailbox).

Your system administrator can configure the period in the Forum 500 / Forum 5000 from 30 to 300 seconds. Ask him what the current time value is.

# Making Calls from the Telephone Book

## The Telephone Book

Approximately 2,000 entries (Forum 523/524, Forum 550/560, Forum 525/525) or 4,000 entries (Forum 5004/5008/5012, Forum 5500) can be saved in your communications system’s telephone book.

This number includes the centrally administered telephone book, the personal entries of all subscribers, and, provided you are using the multi-company version of the Forum 500 / Forum 5000, the entries in the companies’ telephone books.

How many entries you can save in your personal telephone book is determined by your system administrator when configuring the Forum 500 / Forum 5000. The personal entries are automatically sorted into the comprehensive register, but can only be viewed on your telephone. (However, the system administrator or a person with the relevant authorisation can delete your telephone book completely.)

For instructions on managing the telephone book, refer to the section entitled *MenuCard “Phone Book”* starting on page 130.

## MenuCard “Phone book”

The entries in the phone books of the communication system can be saved within the system itself or in an external address directory (LDAP server, configured by the system administrator). A combination of these storage locations is also possible. The storage locations of phone book entries do affect phone book searching (see following description).



Search mode if the entries are stored in phone books of the communications systems: **Briefly** press the ABC key. You see the **Name:** input field in the upper line of the display.



If you now press the OK key, the complete list of phone book entries saved on the communications system is displayed. The list is sorted alphabetically and you can page to the desired entry.



Search mode if the entries are stored on an LDAP server: Enter the first few letters of the desired entry and press the OK key.

The list of phone book entries located is displayed. All suitable search results are listed, no matter where they are saved.



Use the arrow key to scroll through the list.



When you pick up the handset, the entry will be dialled. If the entry has multiple numbers, the preferred number will be dialled.

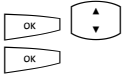

If an entry has multiple call numbers, you may also directly select one of them. Press the OK key and select **Office**, **Mobile** or **Private**. Confirm your selection with the OK key and **Dial** (or pick up the handset). Select **Info** to display the call numbers of the entry.

## Speed-Dialling

All central telephone book entries can also be selected by two-digit or three-digit speed-dialling numbers once they have been configured. The two-digit speed-dialling numbers are in the range 00...99, the three-digit are in the range 000...999. Ask your system administrator how many digits are valid.

### Selecting a speed-dialling destination



alternatively:



**Note:** If you have the telephone book open, instead of keying in the name, you can also press the star key  and enter the speed-dialling destination to find the name entry.

## Add Phone Numbers to Telephone Book from Lists or during a Call

You can add phone numbers saved in your call list or your redial list to a telephone book (see *MenuCard "Calls"* starting on page 112 and *Redialling* starting on page 51). You can also add the other party's phone number to the telephone book during the call (see *MenuCard "Conversation"* starting on page 63).

Select the **Phone Book** menu item.

- **1 New entry:** You can add the phone number to a telephone book.
- **2 Add:** You can add the phone number to an existing telephone book entry.

## Add phone number as new telephone book entry



Select **1 New Entry** and press the OK key.



**Personal, Central, Company:** You can add the entry to your personal telephone book. If your system administrator has given you (or the user group you are part of) the relevant authorisation, you can also edit the central telephone book and your company's telephone book. Select the desired telephone book and press the OK key.



**Office, Mobile, Private:** Define the kind of phone number the list entry should be saved as. Confirm your selection with the OK key.



Enter **Name** and **First Name**. Confirm each entry with the OK key.

You can add to the telephone book entry by entering further phone numbers.



If you add the entry to the central telephone book, you can assign a speed-dialling number. Select **Abbrev. no.** and press the OK key. The system will offer a speed-dialling number. You can accept this number or enter another one which is not in use.



If the newly entered phone number is to be dialled automatically whenever you call the subscriber (by using the telephone book) you can save this number as a default number. To do this, select the list item **Default** and press the OK key.



You can define whether or not your own call number is automatically transmitted if you call this call number. Select **Transmit number** and confirm with the OK key.



Select in the **Transmit number** MenuCard which kind of call number the list entry is to be saved as (**Office, Mobile, Private**) and confirm with the OK key.



Select one of the following options and confirm the selection with the OK key:

- **Default:** You can decide before calling this call number whether or not your call number is to be transmitted or not (refer to the *MenuCard “Selection” in the Idle State* starting on page 57 chapter also).
- **yes:** Your call number is always displayed.
- **no:** Your call number is always suppressed.



To save the telephone book entry, select the **Save** menu item and press the OK key.

### Add phone number to a telephone book entry



Select **2 Add** and press the OK key.



**Personal, Central, Company:** You can add the entry to your personal telephone book. If your system administrator has authorised you (or the user group you are part of) accordingly, you can also edit the central telephone book and your company’s telephone book. Select the desired telephone book and press the OK key.



In the relevant telephone book, select the entry you would like to add to (please also refer to the explanations under “Look up name” in the section *MenuCard “Phone book”* starting on page 88).



**Office, Mobile, Private:** Define the kind of phone number the list entry should be saved as. Confirm your selection with the OK key.



Add more information to the entry as described in *Add phone number as new telephone book entry* on page 90.



To save the telephone book entry, select the **Save** menu item and press the OK key.

# Hot Desking: Your Telephone Goes Wherever Your Desk Is

“Hot Desking” means that you log in to the telephone at your desk and your call number and your telephone settings are available to you on that phone. This function is particularly interesting for companies whose staff travels quite a bit. When a “Hot Desking” user is working in the office, he/she simply logs in to any available telephone. This telephone will then have the corresponding properties and profile of the logged in user. When he/she makes a call from this phone, his/her name and call number are what the caller sees. And vice versa - the user can be reached via his/her usual call number.

**Note:** The “Hot Desking” function can only be used on the Forum Phone 525 and Forum Phone 535 system phones, but not on the Forum Phone 515.

To be able to use this function, the system administrator has to configure a user interface for you for a system telephone. This involves saving your internal call number along with a certain terminal type in the database of the communications system. When you load this user interface to a system telephone, you can programme keys, add telephone book entries, edit lists, etc. as you usually do. All these settings are always saved along with your user interface and placed in the communications system database.

## **Which system telephones can i use?**

This function is supported on the standard system telephones Forum Phone 525 and Forum Phone 535, as well as the IP system telephones Forum IPhone 525 und Forum IPhone 535 (please refer to the chapter *VoIP Telephones* starting on page 95 also). The user interfaces are compatible with standard system telephones and IP telephones. When the system administrator has configured a user interface for you for the Forum Phone 535, you can load it for the same type of IP telephone, the Forum IPhone 535 and vice versa. The same applies to the Forum Phone 525 and Forum IPhone 525 telephones.

The system administrator can set up multiple user interfaces for your internal call number, e. g. for a Forum Phone 525 and a Forum Phone 535, so that you have a wider selection to choose from. If you have multiple internal call

numbers, the system administrator can set up user interfaces for each of these.

### Which system telephone is “available”?

The “available” system telephones display **Logged out** in their info line. To log in to one of these telephones, please go through the following steps.

### Logging in to a system telephone



Press the MenuCard key.

The MenuCard **Login** will open.

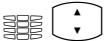

Under **No.:**, enter your internal call number and under **PIN:** enter your user PIN. If necessary, the system administrator will have given you a user PIN to ensure that no other user can log in to your user interface (and use or alter your telephone settings). If you have not yet received a user PIN, skip this entry with the arrow key. If multiple user interfaces are saved to your call number or if you have multiple internal call numbers, a pick-list will appear. Use the arrow key to select the desired entry.



Select the **Login** menu entry and press the OK key.

### Tip:

A feature key (labelled **Login**) enables you to easily log in to system telephones that are logged out. Press this feature key and the MenuCard for logging in will appear.

### Logging yourself or another user out

Use the following steps to log out yourself or another user (if the other user has forgotten to log out).



**Long** press the MenuCard key, then ...



select MenuCard **5 Protection**, press the OK key.



Select the **0 Logout** menu item, press the OK key.



Confirm the security prompt by pressing the OK key once more.

**Tip:** Programming a feature key enables you to log yourself out at the press of a key (see the chapter *Programming Functions (Features)* starting on page 138).

### **What happens if someone calls me and i am not logged in to a system telephone?**

When you are logged out, system telephones offer functions comparable to the “Call protection” feature. When a person calls you, he/she hears the ring tone. This call will be saved in your call list. The next time you log in to your system telephone, you can query the call list and call the person back.

### **Can i make a call from a system telephone that is logged out?**

No, system telephones that are logged out cannot be used to make calls, with one exception: **Emergency numbers** can be dialled.

### **Logging in and out with the Forum CTI**

If you use the **Forum CTI** programme package at your desk, you can log in to any available system telephone via this programme. You can configure the **Forum CTI** so that when you launch the programme you are automatically logged in to a system telephone. This programme also offers logging out of a system telephone. For more details, please refer to the online help of the **Forum CTI**.

### **For the system administrator**

- The “Hot Desking” function is activated in the menu **Telephony > Devices > Hot Desking**. This is also where you can configure user interfaces, i. e. assign selected internal call numbers to terminals. Users with these call numbers are then able to use this function at the telephones so defined.
- Select the telephones to which user interfaces may be loaded in the menu **Telephony > Ports > Upn**.
- Assigning a user PIN provides log-on protection for system telephones. This PIN is entered in the menu **User manager > User**.
- The call numbers that can be dialled from a logged out telephone (e. g. emergency numbers) are managed in Special list 1 (menu **Telephony > Lists > Special lists**).



---

# VoIP Telephones

VoIP stands for “Voice over IP” and refers to telephony where voice data is transmitted via Internet Protocol (IP). VoIP enables companies to use existing company data lines without having to lay new telephone lines. To be able to use this technology, however, suitable devices which support it are necessary.

The following IP system telephones are suitable, e. g. Forum IPhone 525 and Forum IPhone 535. These telephones offer the same range of functions that the Forum Phone 525 and Forum Phone 535 standard system telephones offer and are operated in exactly the same way. The number of keys and their functions and the displays are the same for both the standard and the IP system telephones. Key extensions can also be connected to IP system telephones (see also the chapter *Key Extensions* starting on page 31).

If your system administrator has configured an IP system telephone for you, the following information will be of interest to you:

- During some connections you may experience short breaks or hear an echo. This depends on the transmission quality of the line and is not due to your telephone functioning improperly.
- If your telephone is being connected to the line or the connection is interrupted (e. g. if the company network breaks down), the required terminal software will be loaded (the telephone “reboots”). This happens automatically and may take some minutes. The telephone is ready for operation when the display shows the time and the internal call number. Then you may use the telephone as per usual.
- When telephoning via connected headset, it is advisable to wait a second after accepting an incoming call before you begin to speak. This brief time interval is necessary to allow the VoIP connection to be established between yourself and the caller.

# IP System Telephone Ports



IP system telephones have additional ports not included with the standard system telephones. Above the display on the back of the device there are two RJ45 jacks for connecting the data line(s). These ports are labelled **LAN** and **PC**. Depending on how your workstation is equipped technically, there are two options for connecting the IP system telephone. Your system administrator will connect the telephone for you. If for whatever reason the lines get disconnected at some point, follow the steps below to reconnect the telephone yourself.

## **Option 1: Your Workplace Computer has a Network Port Available.**

Insert the network cable into the telephone's **LAN** port and the other end of the cable into the available network port.

## **Option 2: Your Workplace Computer has just One Network Port Available which is Used by Both Telephone and PC.**

The telephone can be looped into the existing network connection via its **LAN** and **PC** jacks. To connect the telephone, use a network cable to connect the telephone to the **PC**, one end of which is inserted into the **PC** port of the telephone. A second network cable is inserted into the **LAN** port of the telephone, the other end of which goes into the network port.

The power supply of the telephone and the connected key extensions is provided by the network feed ("Power over Ethernet"). If your company network does not supply Power over Ethernet, the telephone will require a separate power supply via an additional AC adapter plug (product code 90035810; product name "Forum 500 power for keypad & FIP 525/535"). The AC adapter plug is plugged into the port on the base of the telephone. This symbol  identifies this port. If there are one or more key extensions connected to this telephone, the AC adapter plug is not plugged into the port on the base of the telephone but into the outside key extension (insert it into the port with the  symbol) and provides power to the entire device.

**Please note:** Never operate an IP system telephone with PoE and AC adapter plug simultaneously!

If you have any questions on this topic, would like some more information or need help with anything in this regard, please contact your system administrator.

# Notes for the System Administrator

The “Mounting and Commissioning” (Forum 523, Forum 525/526, Forum 550/560, Forum 5004/5008/5012) resp. “Commissioning and Maintenance” (Forum 5500) guide contains detailed information on VoIP and how to commission and configure IP system telephones.

**Please note:**For feeds to IP system telephones, Power-over-Ethernet function in accordance with **IEEE 802.3af - class 3** standard is required!

**Note:** Use a shielded CAT-5 Ethernet cable (STP cable, Shielded Twisted Pair cable) to connect an IP system telephone to a Local Area Network (LAN).

# Team Functions

The system administrator can form a team with two or more telephones and programme team functions for these telephones by assigning internal call numbers to the telephone's call keys. For each programmed call key, the administrator can determine whether you can receive and make calls or whether you can only call the other members in the team.

As a member of a team, you can see on your display which of the other team members are currently busy. Team members can answer one another's calls and transfer them. They can also substitute for one another.

For an overview of team functions and some examples of how they are used, please refer to the chapter entitled "Team Functions" in the "Mounting and Commissioning" (Forum 523, Forum 525/526, Forum 550/560, Forum 5004/5008/5012) resp. "Commissioning and Maintenance" (Forum 5500) guide.

For information on the display texts, please refer to the chapter entitled *Display and MenuCards* starting on page 23; for information on the call keys, refer to the chapter entitled *Key Assignments* starting on page 12.

## Managing Calls in a Team

In a team configuration, the operation of call keys is very similar to the operation described in the previous chapters of this user guide.

This chapter gives a brief explanation of how to operate the telephones in a team configuration and refers you to other chapters where appropriate.

## Making External/Internal Calls

For information on how to operate these functions, please also refer to the chapter entitled *Making External/Internal Calls* starting on page 58.

## Using trunk keys



Trunk key 1 is automatically seized when you lift the handset, press the hands-free/open-listening key or the headset key (prerequisite: the headset is switched on, see page 122). You can make internal and external calls.



If you have programmed several trunk keys on your system telephone, you can seize them separately.

## Using team keys



To call another team member, simply press their team key.

## Using direct-call keys



Via direct-call keys you can call team members even if they have programmed a substitute.

# Accepting Calls

For information on how to use this function, please also refer to the chapter entitled *Accepting Calls* starting on page 67.

## Using trunk keys

Calls are indicated on the appropriate trunk key by a visual signal and (if configured) acoustically as well.



You can accept the call by picking up the handset, or



pressing the trunk key, or



pressing the hands-free/open-listening key, or



pressing the headset key (prerequisite: the headset is switched on, see page 122).

With the trunk keys you can set your telephone to idle either by programming call protection, call forwarding or a substitute. You can also change the call signalling mode via the trunk keys (see the section entitled *MenuCard “Prog. call key” (Trunk Key)* on page 102).

### Using team keys

 For calls for another team member, the call number of the caller (or the name if there is a corresponding entry in the telephone book) and the user name of the team member are shown alternately in the display. You can accept a call for another team member by pressing the appropriate team key on your telephone. You can put the accepted call through to the team member using the team key.

You can change the call signalling mode via the trunk keys (see the section entitled *MenuCard “Prog. team key”* starting on page 104).

### Using direct-call keys

 Via direct-call keys you can only make calls to team and trunk keys programmed with the same call number. No calls are signalled to direct-call keys.

## Enquiry, Toggling and Transferring

For information on how to use these functions, please also refer to the chapter entitled *Enquiry, Toggling, Transfer and Conference* starting on page 71.

Within a team you can put a call on hold for enquiries or transfers. Calls on hold are indicated by the LED flashing slowly on your telephone.

While the call is on hold you can make an enquiry call to another member in the team and transfer the call.

The following is a brief description of all call keys (trunk key, team key, busy key and direct-call key).

### Enquiry calls



Press the call key of the team member with whom you want to consult. The original call is put on hold.

## Toggling



To toggle (i.e. switch back and forth between the two subscribers in the call), press the key of the held subscriber.

## Transferring



Announce the call transfer to the other team member and put the handset on the hook. The call on hold is now transferred to the other team member.

## Holding and transferring calls with a feature key

Using the “Hold” function, team members can accept a call that has been parked by another team member. To use the “Hold” function, it must be programmed to an unused feature key on the team members’ telephones.



You are speaking via a call key, e. g. the trunk key with the call number 11.

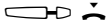

Press the “Hold” feature key to put the call on hold. Put the handset on the hook.

On the team telephones with the call number 11 programmed on a trunk key or a team key, the LED for the programmed key flashes. The display indicates that a call for the call number 11 is put on hold (is parked).



**Accepting Calls with a Team Key:** Another team member presses the team key to which the call number 11 has been assigned.



**Accepting Calls with a Trunk Key:** Another team member presses the trunk key to which the call number 11 has been assigned.

For information on how to programme the feature keys, please refer to the chapter entitled *Programming Functions (Features)* starting on page 138.

# Programming the Call Keys

The call keys are configured in the **Configurator** on the Forum 500 / Forum 5000 Web console. For **system telephones**, you can configure the following:



- the type of key (trunk key, team key, busy key or direct-call key),
- the call number and the text currently assigned to the key,
- the call signalling mode for this key.

You can change the pre-settings for the text and the call signalling mode on the appropriate key's MenuCard (see the following sections: *MenuCard "Prog. call key" (Trunk Key)* on page 102 and *MenuCard "Prog. team key"* on page 104) as well as most of the settings for supported features.

If the configuration of a call key is changed in the **Configurator**, the telephone will load the new settings and not be operational for a few moments. For more information on the configuration, refer to the online help of the Forum 500 / Forum 5000.

## MenuCard "Prog. call key" (Trunk Key)

 **Long press** the trunk key, then select ...

**1 Modify text:** You will see the text currently assigned to the key. This text is displayed on the display of your telephone. To change the text, press . Delete the existing text with the  key and enter new text, if required. Press  and confirm this with **Save**. If you delete the text, only the key's call number will be displayed.

**2 Call diversion:** You can configure one or more types of call forwarding for the trunk key (**Immediately, After delay, Busy**), see the section entitled *MenuCard "Call Forwarding"* starting on page 117. The call forwarding mode configured for a trunk key only applies to that key, not the telephone.

**3 Substitution:** You can forward calls for this trunk key to another member of the team. Select **Substitute** and choose one of the team members from the list. Press . Select **On/Off** to switch the substitution function on or off.

**Note:** The **3 Substitution** menu entry is only displayed if the allocated call number has been configured on another team member's trunk or team key.



Calls for this trunk key are now only indicated on your telephone by a visual signal. On the substitute's telephone, the calls are indicated by a visual signal and acoustically, even if the key there has been configured with a different type of call signalling. On the substitute's telephone, the call is signalled acoustically with the volume set for that telephone (see the section entitled *MenuCard "Phone Settings"* on page 121).

Calls from direct-call keys to your telephone are signalled acoustically even if you have programmed a substitute (unless you have programmed call protection for this trunk key).

**4 Call signalling:** Determine whether call signalling to this key is to be **Optical & acoustic**, **Optical only** or **Acoustic after delay**. If you select **Acoustic after delay**, specify the number of seconds after which your telephone is to ring.

**5 Call protect:** Switch call protection **On** or **Off** for all calls, for internal calls only, or for external calls only. If call protection has been activated, this trunk key will only indicate calls by means of a visual signal, even if they are made from a direct-call key.

**6 Ring tone:** You can set the **1 Volume** and **2 Melody** for different types of incoming calls (**1 External calls**, **2 Internal calls**, **3 VIP call**, **4 Door call**) for each trunk key. Proceed as described in the section **2 Ring Tone** on page 121.

**7 Charges:** For this trunk key, you can view the charges for the last call as well as the total charges.

**8 Call wait. prot.:** While you are making a call, other calls for the call number of this trunk key are not signalled by a call waiting tone. The caller hears the busy tone.



**Note:** If the internal call number of this trunk key is configured on several telephones, call waiting protection is also activated on these telephones.

**9 Announcement pro...** (Announcement protection): Switching on (**On**) or switching off (**Off**) announcement protection for this trunk key. When announcement protection is activated, no announcements can be made to your telephone (see also page 75).

**0 Lists:** Define if for the call number of this trunk key the caller lists (missed calls and accepted calls) and the redial list are recorded. Use **On/Off** to activate/deactivate the lists for this trunk key.

## MenuCard “Prog. team key”

☞ **Long press the team key, then select ...**

**1 Modify text:** The text currently assigned to the key is shown on the display of your telephone. To change the text, press . Delete the existing text with the  key and enter new text, if required. Press  and confirm this with **Save**. If you delete the text, only the key’s call number will be displayed.

**2 Call signalling:** Specify whether call signalling to this key is to be **Optical & acoustic**, **Optical only** or **Acoustic after delay**. If you select **Acoustic after delay**, specify the number of seconds after which your telephone is to ring.

**3 Call protect:** Switch call protection **On** or **Off** for all calls, for internal calls only, or for external calls only. If call protection has been activated, this team key will only indicate calls by means of a visual signal, even if they are made from a direct-call key.

**4 Ring tone:** You can set the **1 Volume** and **2 Melody** for different types of incoming calls (**1 External calls**, **2 Internal calls**, **3 VIP call**, **4 Door call**) for each team key. Proceed as described in the section **2 Ring Tone** on page 121.

**5 Call wait. prot.:** While you are making a call, other calls for the call number of this team key are not signalled by a call waiting tone (but at the team keys of other terminals unless call waiting protection was programmed there). Use the **On/Off** options to switch the call waiting protection function on or off.

**6 Lists:** Define if for the call number of this team key the caller lists (missed calls and accepted calls) and the redial list are recorded. Use **On/Off** to activate/deactivate the lists for this team key.

## Direct-call Key

When a direct-call key is long pressed, no MenuCard is displayed. A direct-call key is configured exclusively via the **Configurator** of the Forum 500 / Forum 5000 Web console.

# Remote-Controlled Functions

The Forum 500 / Forum 5000 enables remote-controlled calls and remote-programmable call forwardings. These features are set up by the administrator when configuring the system. The system PIN is required to carry out these features.

The system PIN is issued by the system administrator, and it must be changed from the factory setting (“0000”) to another value for the features described below to function.

All the owners of voiceboxes can also call their voiceboxes from external telephones if they are authorised to do so. They can remotely access and edit their messages as well as modify the central settings of their voiceboxes.

## Remote-Controlled Dialling (Call Through)

### Without internal number assignment



Enter the reserved call number.



Enter the system PIN.



Press the star key.



Enter the trunk line seizure code, e. g. .



Enter the external call number.



Press the hash key.

### With internal number assignment



Enter the reserved call number.



Enter the system PIN.



Press the star key.



Enter the trunk line seizure code, e. g. .



Enter the external call number.



Press the star key.



Enter the internal call number.



Press the hash key.

You can call the Forum 500 / Forum 5000 from an external telephone, from your home for example, and then dial an external call number. The cost of the call is then billed to the Forum 500 / Forum 5000 line. This way you can take advantage of different tariff zones, for example.

For this feature, the system administrator must have set up a call number (for remote control) in the Forum 500 / Forum 5000. In addition, the number reserved in the Forum 500 / Forum 5000 can also be assigned an internal call number via which the dialling is to be performed. In the case of remote-controlled dialling, there is no check on authorisation.

Least Cost Routing (LCR) is used with remote dialling, provided the system administrator has correspondingly configured LCR and its application in the Forum 500 / Forum 5000. Ask your administrator for the configuration applicable to you.

# Remote-Programmable Call Forwarding

## Configuring the function



Enter the reserved call number.



Enter the system PIN.



Press the star key.



Enter your internal call number.



Press the star key.



Enter the trunk line seizure code, e. g. .



Enter the destination call number.



Press the hash key.

## Deleting the function



Enter the reserved call number.



Enter the system PIN.



Press the star key.



Enter your internal call number.



Press the hash key.

Using the call number reserved in the Forum 500 / Forum 5000 for remote control, you can configure or delete call forwarding “Immediate” for your own call number from a remote location. This remotely-programmed forwarding overwrites any other existing call forwarding. Call forwarding “On Busy” and “After Delay” are not affected. Incorrect or non-existent call numbers are rejected. Your authorisation is checked in the same way as for call forwarding within the Forum 500 / Forum 5000.

A correct entry is confirmed with a positive acknowledgement signal, provided the system administrator has not deactivated this function (in the **Configurator, Telephony > Settings** menu). The external call is subsequently ended.

**Note:** The procedure is aborted if there is a pause of longer than 60 seconds between the entry of two digits. With this duration, remote-controlled functions using GSM cell phones can also be realised.

## Remote-Programmable Voicebox Configuration and Query

If the system administrator has configured remote query authorisation for your voicebox, you can query and configure your voicebox from an external telephone:

- Using the call number of **Forum Voicemail** (this number is included in the incoming call distribution) ...  
you dial the MSN or the system number assigned by the system administrator to the internal number of **Forum Voicemail**.
- Using your own call number (this number is included in the incoming call distribution, and you have activated call forwarding for this telephone to the voicebox) ...  
you dial the MSN or the direct-dialling in number under which you can be reached by external callers.

**Note:** For detailed information on the utilisation and operation of **Forum Voicemail**, please refer to the add-on guide "Forum Voicemail".

## Setting up an Internet Connection from Remote (ISP Trigger Call)

If the communications system is connected to the Internet via a dialup connection, a user can initiate from external that the system establishes an Internet connection (ISP Trigger call). The system is then reachable via the Internet and enables to set up a connection for a VPN connection via RAS.



Enter the reserved call number.



Enter the system PIN.



Press the star key.



Press the hash key.

**Note:**

The “ISP Trigger call” function is only available with a Forum 523 communications system.

# Features and MenuCards

## How to Set Features

You can set the features of your telephone and system in several different ways:

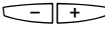

### Using MenuCards

Invoke the MenuCards using the appropriate key as described under *Display and MenuCards* starting on page 23 and define your settings. Use the arrow keys and the  key to select your settings and the  keys to switch between settings. In the primary groups of MenuCards you can also select features directly by entering a number. To do this, simply key in the number to the left of the feature.

### Using feature keys

Almost all features can be assigned to your telephone's feature keys then called up by pressing the key or by switching the function on or off (see *Programming Functions (Features)* starting on page 138.)

### Using the star and hash keys

Many features can be set by entering code digits. Code digits are entered using the  or  keys in combination a specific string of code digits.



Code digit input is intended primarily for analogue telephones in your system. The code digits can also be used on your system telephones. These are described in the "Forum 500 / Forum 5000 – Standard Terminals" user guide (supplied with the system). You can also view a current online overview of codes under the **Codes** item in the **Systeminfo** menu of your communications system's Web console.

## Main Menu

### MenuCard "Main Menu"

This MenuCard contains all available features. Some of the menu items can be found in other MenuCards as well. Incoming e-mails, for example, are under **3 Messages** in the Main menu and can also be called up by using the info





key  (where the system has been so configured). Features affecting your telephone's availability (e. g. active call protection) are in the Main menu and in the MenuCard **8 Active features**, which you can call up by long pressing the info key .

You can also use the Main menu to programme features on a key.

 **Long** press the MenuCard key, or if the telephone is idle, **short** press the MenuCard key and select the menu item **Main menu**. This displays the primary groups of menus ...

- 1 Calls:** This contains the most important features relevant to a call.
- 2 Call forwarding:** This menu group contains all the types of call forwarding you can programme on your telephone. Please keep in mind the explanations in the chapter *Forwarding Calls* starting on page 78.
- 3 Messages:** This menu group provides information on short messages and e-mails that you have received or sent. You can also schedule appointments and activate pre-defined messages ("Presence" function).
- 4 Phone settings:** In this menu group you can adjust the telephone's settings to suit your personal requirements, e. g. volume, ring tone settings, and display contrast.
- 5 Protection:** Here you can activate call protection or the telephone lock, among other things.
- 6 Connections:** This menu group provides you with all the features that can affect a call. Depending on the particular state, these features are also displayed in the MenuCards that you can call up during a connection.
- 7 Phone book:** You can edit the system telephone books in this menu group.
- 9 Applications:** This menu group contains all functions offered by your system telephone in conjunction with additional programme packages of your communications system. If your system administrator has set up, e. g. a voicebox with the **Forum Voicemail** additional programme for you, a menu will be offered to you here for querying and configuring your voicebox.
- 0 Central settings:** You can change your system settings here.

## MenuCard “Calls”

  Select **1 Calls**, then ...

select **1 Call lists**, followed by ...

**1 Missed calls:** Here you can see the call numbers of callers who have tried to reach you. This also applies to calls transferred or forwarded to you from other internal subscribers. The entry will automatically be deleted after you have called back the caller. Specific feature for missed standard hunt group calls: If a hunt group member has called back the caller, the missed call entry will be deleted in the caller lists of members of this standard hunt group.

- Which calls are recorded in your call lists is determined by the authorisations of your user group. Your system administrator can specify that internal calls, external calls, calls when busy, and calls from the door all be included in your call list. If a caller is listed in the system’s telephone book, the caller’s name is displayed instead of the call number.

- A call when busy is indicated by the handset symbol .

- The  symbol indicates calls which were forwarded to you.

- When you receive an external call where the caller indicates a different number than the one actually being transmitted, your display will show a “?” next to the call number. If the indicated call number is saved as a phone book entry, as usual, the name will be shown along with a question mark. Note: Display of the “?” can be deactivated by the system administrator.

- When there is a door call, either the call number or the name of the doorbell is displayed. The name is displayed if the call number of the door has its own phone book entry, or the system administrator assigned a name when the doorbell was configured.

- If a caller has suppressed the display of his or her call number using CLIR, the call will still be shown in the call list. Where several calls from unknown numbers have been made, they are grouped together into a single entry. The system administrator can, however, during system configuration, determine that any

calls with unknown call numbers will not be included on your call list.

**Note:** If your internal call number (e. g. “30”) is assigned to several telephones, you can view and edit the call list for the call number 30 on any of these phones. If, for example, you delete a call list on one telephone, it is deleted on all telephones.

## Callback



Select an entry (call number or name) and press the OK key.



You can open the telephone book by pressing the ABC key while the handset is **on the hook** (see below for further explanation).



If you press the OK key while the handset is **on the hook**, you can then perform the following actions:

- **Dial:** Call the caller back. Press the OK key or pick up the handset.
- **Phone book:** To add an entry to the telephone book (**1 New Entry**) or add to an existing entry (**2 Add**). See also: *Add Phone Numbers to Telephone Book from Lists or during a Call* starting on page 89.
- **Info:** Provides you with information on callers (e. g. call number, if the caller’s name is displayed in the call list), time of the call and number of calls. When you have multiple trunk keys configured on your telephone, the trunk key on which the call was received is indicated.

**2 Accepted calls:** Here you can see the call numbers of the callers you last spoke to. You can also edit this list in the same way as the list for missed calls (see page 112).

**Note:** Calls which have been signalled on your telephone’s Team keys are not entered into your call list.

**3 Voicebox mess.:** Here you can see and edit the list of messages received.

**Play:** To listen to the message the caller recorded. You can also use the number keys **4** (to rewind), **5** (to pause) and **6** (to fast forward).

**Delete:** The message will be deleted after you press .

**Dial:** To call a caller back. Press  or pick up the handset.

**Phone book:** You can add an entry to the telephone book (**1 New Entry**) or add to an existing entry (**2 Add**). See also: *Add Phone Numbers to Telephone Book from Lists or during a Call* starting on page 89.

**Forward:** You can forward the message to another voicebox, with or without a comment. Enter the call number of the other voicebox under **Dest:** and confirm a recorded comment by pressing .

**Mark as new:** If the message is addressed to another person and you accidentally have listened to it, you can use this menu option to reset the messages to the status “new”.

**Info:** Here you can see a caller’s call number (or name, if it is entered in the telephone book) and the date, time and length of the selected message. When you have multiple trunk keys configured on your telephone, the trunk key on which the message was received is indicated.

**4 Recordings:** You will only see this menu entry if the system administrator has enabled the function “Call recording” for you (also see chapter *Call Recording* starting on page 82). You can see and edit the list of your recordings (calls and audio conferences). When a call is recorded, the name or the number of the caller is displayed. If an audio conference is recorded, the conference room or the conference invitation is shown as a name. Select the desired entry from the list. Then select ...

**Play:** To listen to the recording. You can also use the number keys **4** (to rewind), **5** (to pause) and **6** (to fast forward).

**Delete:** The recording will be deleted after you press .

**Note:** A recording is only stored in the communications system once. If you share a voicebox with several users of the communications system, a recording is only deleted from the system when the last user deletes the recording.

**Dial:** To call the conversational partner. Press  or pick up the handset. This menu item is not displayed when you selected an audio conference recording.

**Phone book:** You can add the call number of the conversational partner to the telephone book (**1 New Entry**) or add to an existing entry (**2 Add**). See also: *Add Phone Numbers to Telephone Book from Lists or during a Call* starting on page 89. This menu item is not displayed when you selected an audio conference recording.

**Forward:** You can forward the recording to another subscriber, with or without a comment. Enter the call number of the other subscriber under **Dest:** and confirm a recorded comment by pressing .

**Info:** You can see duration, date and time of the recordings as well as the internal call number you used during the recorded call. During a call recording, the name or the number of the caller is displayed. If you record a conference, the conference room or the conference invitation is shown as a name.

**2 Charges:** For each trunk key, you can view the charges for the last call as well as the total charges.

**3 Remote charges...:** You can view the charges of other Forum 500 / Forum 5000 users by entering the other user's internal number or by selecting a number from the telephone book.

**Note:** This function requires that the system administrator has assigned "Costs" authorisation to your user group.

**4 Hunt group:** If standard hunt group numbers are configured for your telephone, you can switch standard hunt group calls to your telephone on or off using **On/Off** (for individual standard hunt group numbers or **All** if you are a member of several standard hunt groups).

If several trunk keys or team keys on your terminal have been assigned to a standard hunt group number, you will first be offered a list of these keys (or more precisely their internal call numbers) when you access this menu item. Select the key for which you want to activate or deactivate the hunt group. If this key is assigned to several hunt group numbers, select a specific hunt group number, or select the option **All** if

the setting is to be activated for all hunt group numbers assigned to this key.

**Note:** If you are the last reachable member of a standard hunt group and you log out then any further callers will hear a busy signal. Depending on the system configuration, external callers can also be forwarded to the exchange.

**Tip:** If you assign a standard hunt group number to a feature key, you can log out from and log onto the standard hunt group by pressing single key (see also *Programming Functions (Features)* starting on page 138).

**5 Comfort hunt group:** If your telephone belongs to one or more comfort hunt group(s), you can use this menu entry to switch comfort hunt group signalling for your telephone on or off. The operation is identical to the operation of the standard hunt groups.

This menu item is only displayed when the feature **Forum Comfort Hunt Group** is enabled in your communications system and if you are a member of one or more comfort hunt group(s). Refer to the “Mounting and Commissioning” guide (Forum 523/524, Forum 525/526, Forum 550/560, Forum 5004/5008/5012) or “Commissioning and Maintenance” (Forum 5500) for detailed information on the “Hunt groups” topic.

**Note:** The system administrator can set up a **comfort hunt group** such that the last accessible group member can log out. If you are the last accessible member of the comfort hunt group and log out, other callers are parked in the call queue of the comfort hunt group. They remain parked there for a maximum of one hour, providing they are not assigned beforehand to a member who has since logged back in. After waiting for an hour, the caller receives a busy signal.

**Tip:** If you assign the call number of a comfort hunt group number to a function key, you can log in or out of the comfort hunt group by pressing a single key (see also *Programming Functions (Features)* starting on page 138).



**6 Auto call Answer.:** You can specify a period of time after which calls to your telephone are answered automatically. Enter the period of time in seconds under **Duration:** (a value between 0 and 99 seconds). Then select whether the automatic call answering should be activated for

**Internal calls, External calls** or for **Int. & Ext. calls**. You can activate this function with **On** or deactivate automatic call answering with **Off**.



**7 Device busy:** If there are multiple trunk keys configured on your telephone, you can configure that as soon as one of the trunk keys is occupied your device is considered busy. Any further callers hear the busy signal. You can activate this function with **On** or deactivate it with **Off**. A “+” appears to designate the function is activated.

## MenuCard “Call Forwarding”

  Select **2 Call forwarding**, followed by ...

**1 Call diversion:** When you have multiple trunk keys configured on your telephone, you can programme call forwarding for each of these keys individually. To do so, select the desired key from the displayed list and press . If the call forwarding should apply to all configured trunk keys, select the **Device** menu entry and press .

Select **Immediately, After delay** or **Busy** to specify the type of forwarding and press . Then key in the **Dest.** of the call forwarding (please refer to the chapter entitled *Manual or Automatic Line Seizure* starting on page 58). **Duration:** When programming call forwarding after time, enter the time in seconds after which a call is to be forwarded (10 ... 120 seconds). If you do not enter a value, the default time interval provided by the system administrator at system configuration is used (default: 20 seconds).

Then select whether **Internal calls, External calls** or **Int./ext. calls** are to be forwarded to the destination (**Dest.**). If you assign the “Call diversion” function to a feature key (see also *Programming Functions (Features)* starting on page 138), you can also enter a **Text** for a label for the key. The label is displayed in the Forum 500 / Forum 5000’s **Configurator** for informational purposes. Activate call forwarding with **On**. Activated call forwarding (**Immediately, After delay, Busy**) is indicated by a “+” sign followed by the call forwarding destination. You can switch call forwarding on or off using the plus/minus key  .

**Note:** All calls to your telephone’s numbers are forwarded. If a number is stored on more than one telephone, calls made to any of the other telephones will also be forwarded.

**3 Divert MSN:** “Divert MSN” is available for multi-terminal accesses. You can use this type of call forwarding to forward incoming external calls to

external destinations for each MSN. Select the MSN (one of the call numbers supplied for the multi-terminal access) that you want to forward. Several MSNs can be grouped together (this is configured by your system administrator) and forwarded to a common destination number. Selecting the **All** menu item lets you forward all configured MSNs to the same destination number.

You need the relevant authorisation to forward MSN groups and all MSNs. Only then will the corresponding items appear in the menu. Contact your system administrator if you have any questions about your authorisation and the current configuration of MSN groups.

After you have selected an MSN, an MSN group or all MSNs, select the type of call forwarding (**Immediately, After delay or Busy**) then enter the external destination (**Dest.**).

**Note:** For this type of call forwarding, the (external) destination number is always entered without the line seizure code.

If you assign “Divert MSN” to a feature key (see also *Programming Functions (Features)* starting on page 138), you can also enter a **Text** to label the key with. The label is displayed in the Forum 500 / Forum 5000’s **Configurator** for informational purposes.

Activate the function using **On**. Activated call forwarding (**Immediately, After delay, Busy**) is indicated in the MSNs selection list by a “+” before the call number. A “?” before the entry (e. g. **? MSN Group 1**) means that different call forwarding types are activated in this group. Using the plus/minus key , you can switch off an activated call forwarding.

**Note:** If “Divert MSN” is activated in the exchange (= external call forwarding, configured by the system administrator), it can take a few seconds after configuring for call forwarding to be activated in the exchange.

**4 Divert door ...:** “Divert door” is available for door calls. Providing you have the relevant authorisation, you can forward door calls to your telephone to another (internal or external) telephone (a so-called “pharmacy line”). If several door bells are configured on your communications system, select first the door bell whose calls are to be diverted. Then key in the **Dest.** of the call forwarding (please refer to the chapter entitled *Manual or Automatic Line Seizure* starting on page 58). You can activate the forwarding function with **On**, and deactivate it with



**Off.** How many door bells are available, depends on the type of entrance intercom you have. Consult your system administrator if you have questions about the configuration of the door bells.

**5 Remote divert:** This function allows you to configure call forwarding for other users' call numbers. Programming call forwarding for a virtual call number is also possible (please refer to *Call for a virtual number (Tele Secretary)* starting on page 67 also). You must have "Call forwarding for other user" authorisation to be able to do this, otherwise this menu item will not be displayed on your terminal. You can also only configure call forwarding for users whose terminal has not been blocked for this type of access (users themselves have authorisation to "Prevent call forwarding by other user"). Please consult your system administrator if you have any questions about these authorisations.

Enter the internal number that you want to forward or select a number from the telephone book. The rest of the procedure is the same as configuring the "Call diversion" function (see page 117).

**6 Follow me:** This type of call forwarding is configured on another than your own terminal. The user's PIN number for the source telephone is required for this function (see page 124). On the other terminal, select the **6 Follow me** item from the **2 Call forwarding** MenuCard. As **Source**, enter the internal call number for which calls are to be forwarded to this telephone. Then enter the **PIN:** of the source telephone. You can switch off the "Follow Me" function with **On/Off**.

You can switch off the "Follow Me" function on the other (source) telephone by switching off the "Call diversion" function.

If the "Follow Me" function is active, all the call numbers of the other telephone are forwarded immediately.

## MenuCard "Messages"





Select **3 Messages**, followed by ...



**1 Short messages:** Short messages can be exchanged between users with system terminals. The communications system also sends short messages to inform you about events, e. g. if a recording could not be started. When a message arrives, an extra window containing details on the sender is shown for four seconds (on the system terminal's display).

**1 Received mail:** A list of senders of messages is displayed.

**Show:** Select an entry and press . You will see the message's "Subject" text, sender and date.

**Forward:** Select an entry. You can now edit the text of the message. Press . Enter the internal number of the user you want to forward the message to or select a number from the telephone book. Press  to confirm the entry/selection of the number.

**2 Outgoing mail:** A list of the messages you have sent is displayed. You can also forward or display these messages as described in the previous section.

**3 New message:** You can send a new message to another user. Enter the text (max. 160 characters) and press . Enter the internal number of the user you want to send the message to or select a number from the telephone book. Press  to confirm the entry/selection of the number.

Messages can also be sent to system terminals via the Web application **Forum CTI**. Please see the **Forum 500 / Forum 5000's** online help for more information.

**2 E-Mail:** Here you can see a list of incoming e-mails (sender). Select an entry: You will see the e-mail's "Subject" text.

The Forum 500 / Forum 5000 can be configured to notify you when you receive an e-mail. When you receive an e-mail, an additional window shows details on the sender for four seconds (on system telephone displays).

**3 Appointments:** Select **1 Appointment 1** or **2 Appointment 2**. Enter the time in **Time**. You can enter a short text (up to 32 characters) under **Reason**. Specify how often you want to be reminded of the appointment: for a **Single Date**, enter the date in **Date**, selecting **Mo - Fr, Sa - Su** or select **Every day**. Activate the appointment with **On**.

When you receive an appointment call, your telephone will ring for one minute with a steadily increasing volume. The appointment number will also appear on the display. Press , to query the reason for the appointment.

**4 Presence:** You can inform other communications system users regarding your presence status, e. g. you are currently not in the office or on

holiday. The text appears on the display of the caller of an internal call provided that the caller's telephone is a system terminal. There are pre-defined message texts available for this. Select the desired text and press .





If no message is to be displayed, select the **Available** text.

You can also write your own message text (maximum length 23 characters). Select the menu item **Text:**, enter your text and press . The text is now saved and selected in the list. You can overwrite this text at any time.

You can also enter and select a text using the **Forum CTI** Web application.



## MenuCard “Phone Settings”

  Select **4 Phone settings**, followed by ...

**1 Volume:** Select **1 Loudspeaker**, **2 Handset** or **3 Headset**. You can change the default volume by using the   keys or by entering a number from  ... . To change the headset's volume, use the procedure described here for changing the headset volume (receiver volume). You can change the microphone volume under Menu **7 Headset** in the **4 Phone settings** MenuCard (see page 122).

**2 Ring tone:** You can configure the ring tones for incoming calls on your telephone collectively or individually. You can specify whether a ring tone is to apply to the entire telephone or whether calls to particular call keys are to be signalled in different ways.



When you have multiple call keys configured on your telephone, select **Device** or – for individual settings – select a key from the list of currently configured call keys.

You can use different volumes and melodies to distinguish between four different types of incoming call: **1 External calls**, **2 Internal calls**, **3 VIP call**, **4 Door call**. You can use the **1 Volume** and **2 Melody** individually for each type of call. Select a setting using the   keys.

**Note:** In the **Configurator** of the Web console, the **Dialling tones as cadences** setting can be used to specify whether melodies are to be played in full or whether all melodies are to be played at the same speed (played as cadences). The setting in the Configurator also affects

melodies on system telephones if selected, so that you may only hear parts of some melodies.

**4 Message ring tone:** You can set different ringer signals to signal messages on your system telephone or calls for members of your pick-up group. These can then be distinguished from one another.





Select **1 Short messages**, **2 E-Mail**, **3 Pick-up** or **4 Voicebox**. For each type of message you can specify **1 Volume** and **2 Melody** or a short beeping tone instead of a melody. The short beeping tone is the default setting for all messages. Use the   keys to select a different setting.



**Note:** When configuring the pick-up groups in your Forum 500 / Forum 5000's **Configurator**, your system administrator can also specify that calls for members of your pick-up group be displayed on your system telephone as well.



**5 En-bloc dialling:** This switches your telephone to automatic dialling (**On**) or direct dialling (**Off**).





**Note:** If you use CTI applications, you should **switch off** the “block dialling” function on your system phone. This applies for all CTI applications, except for the application **Forum CTI**.

**6 Charge settings:** The charges for automatically dialled external calls can be displayed on the system telephone as an amount (**Charge** per call), provided your network operator transmits information about charges. Alternatively, the **Duration** for internal or external calls can be displayed on the system telephone. The **Off** setting means that no charges are displayed.

**7 Headset:** If you use a headset with your system telephone, you can switch this function on and off here. When the headset is switched on you can make and accept calls by pressing the headset key . To switch this function on and off select **1 Headset** and then the option **On** or **Off**. If Option **1 Headset** is switched off, the headset key on your system telephone will not function. You can adjust the volume of the headset and the microphone to six different levels using the menu items **2 Receiver vol.** and **3 Sender vol.**. Use the plus/minus key   to adjust the volume, or enter a number between  ... .







**8 Display:** Select **1 Contrast** or **2 Language**. **1 Contrast** lets you adjust the contrast levels of the display using the   keys (or by entering a

number from  ... ). **2 Language** enables you to directly select the display language from the list of available languages.

If your Forum Phone 535 has had one or more key extensions added to it, the contrast levels of the display can be set separately for each key extension. Select **1 Contrast** and select the relevant **Expansion** from the menu that appears. Adjust the display's contrast levels incrementally using the   keys or enter a number between  ... .

## MenuCard “Protection”

  Select **5 Protection**, followed by ...

**1 Call prot. phone:** (call protection phone) This switches call signalling on your telephone for all calls or for internal only/for external calls only **On/Off** (with the exception of VIP and hunt group calls). When there are multiple trunk keys configured on your telephone, you can switch call protection for each of these keys on or off. To do so, select the desired key from the displayed list and press . If call protection should apply to all configured trunk keys, select the **Device** menu entry and press . The most recently activated call protection appears in the first line. To change this setting, select , then the type of protection (**Int./ext. calls**, **Internal calls** or **External calls**) you want to use. Press  to confirm your choice and activate the function with **On**. You can switch call protection on or off using the plus/minus key  .

You can also configure call protection for a trunk key by **long** pressing the corresponding trunk key and selecting the **5 Call protect** menu item.

When call protection is activated, the caller hears either the ring tone or the busy tone (this is configured by the system administrator as part of the user groups configuration). Calls from direct call keys are only signalled visually on this trunk key.

**Note:** This type of call protection is only activated on the telephone on which it was set. If your internal call number is configured on the trunk or team keys of other telephones, call protection is not automatically activated on those telephones.

**2 Announcement pro...:** (Announcement protection) Switching on (**On**) or switching off (**Off**) announcement protection for your device. When announcement protection is activated, no announcements can be made

to your telephone (see also page 75). When there are multiple trunk keys configured on your telephone, you can switch announcement protection for each of these keys on/off. To do so, select the desired key and press .

**3 Telephone lock:** If you wish to temporarily allow another person to use your telephone, you can activate the telephone lock. Then your telephone is given the authorisations for the “Guests” user group. This user group is configured by the system administrator and prevents unauthorised persons from accessing, reading or making changes in the telephone’s menus and lists. Dialling rights may also be restricted. Emergency numbers can be stored in a special list assigned to your user group which can always be dialled, regardless of the external authorisation. Please contact your system administrator for information on the altered range of functions when the telephone lock is on. Telephone lock access is user-PIN protected. After entering the PIN (**PIN:**), activate the function with the **On** option.



When the telephone lock is activated, the LED of the info key  is illuminated while the info key is without function then.

**4 Baby call:** Enter the destination (**Dest.:**). Activate the baby call with **On**.

**5 Change PIN:** Enter your old user PIN then enter your new PIN twice. Contact your system administrator if you have forgotten your user PIN. Your user PIN can have up to six characters.

**6 Delete keys:** After entering you user PIN (**PIN:**) all functions and numbers that you have assigned to the keys are deleted.

**7 Availability:** All active features that hinder your availability (call protection, call forwarding, call waiting protection), are cleared.

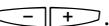
**8 Call wait. prot.:** (call waiting protection) During a telephone conversation, no further calls are signalled by the call waiting tone. Activate the function with **On**. When there are multiple trunk keys configured on your telephone, you can switch call waiting protection for each of these keys on or off. To do so, select the desired key from the displayed list and press . If call waiting protection should apply to all configured trunk keys, select the **Device** menu entry and press . You can switch call waiting protection on or off using the plus/minus key .

**Note:** Call waiting protection is only activated on the telephone on which it was set. If your internal call number is also stored on the trunk

or team keys of other telephones, call waiting protection is not automatically activated on these telephones.

**9 Intercom prot.:** (Intercom protection) Switching on (**On**) or switching off (**Off**) intercom protection. When intercom protection is activated, no intercom announcements can be made to your telephone (see also page 75).

**O Logout:** If the “Hot Desking” function is configured by the system administrator and you are logged in as user on the system telephone you can use this menu item to log out. For more information on this function please refer to the chapter entitled *Hot Desking: Your Telephone Goes Wherever Your Desk Is* starting on page 92).

**Note:** The “Hot Desking” function can only be used on the Forum Phone 525 and Forum Phone 535 system telephones, but not on the Forum Phone 515.

## MenuCard “Connections”

**Note:** The following features are carried out if this is permitted by the current call state of your telephone. These features are also in the call-dependent MenuCards. Some entries in the **6 Connections** MenuCard are only shown when you programme the function onto a function key (please refer also to the chapter *Programming Functions (Features)* starting on page 138).



Select **6 Connections**, then ...

select **1 Call pick-up**, followed by ...

**1 Pick-up:** This accepts a call for another telephone in your pick-up group.

If the person called is a member of a user group for which pick-up protection is active, you can not pick up calls to their number.

**2 Pick-up select...:** You can answer a call for any other telephone. To do this, enter the call number of the other telephone. If the other terminal is already in the call state (e. g. an answering machine is in announcement mode), you pick up the call. The person for whom you pick up the call must belong to a user group for which “Call seizure” authorisation is activated, otherwise the “Pick-up selective” function can not be used.

If the person called is a member of a user group for which pick-up protection is active, you can not pick up calls to their number.

**3 Take:** You accept a current call from a different terminal at your system telephone and continue your call on your system telephone. The prerequisite is that your system telephone and the other terminal have the same internal call number.

**4 Unpark call:** “Unparks” a previously “parked” caller (see also *MenuCard “Conversation”* starting on page 63).

If you program the **4 Unpark call** function to a function key, the LED of the key lights up when one or more calls are parked. If you press the function key, a list of the parked calls is displayed. Select the desired parked call from the list to unpark the call. Confirm with the  key. Read the *Programming Functions (Features)* starting on page 138 chapter regarding programming of function keys.

Select **2 Dial**, followed by ...

**1 Announcement:** You initiate an announcement to other **system terminals**. Under **To:** enter the call number. Announcements can also be directed to call numbers at which several callers can be reached (e. g. a hunt group call number).

**Note:** If a called user has activated the announcement protection (see page 123), this feature is not carried out.

**2 Intercom:** Use this function to initiate an announcement **to a single system terminal**, The microphone of the system terminal will be switched on (see also page 75). The person you are calling can immediately answer your announcement without having to press a key. Enter the device ID of the terminal for **Device-ID:**. For information on the existing device IDs, speak with your system administrator.

**Note:** If the called user has activated the intercom protection (see page 125), this feature is not carried out.

**3 Door opener:** This activates the door opener.

**4 Phone book:** Opens the telephone book (see page 89).

**5 Note:** Note a call number and a name or dial a previously noted call number.



**6 Suppress number:** Your call number is not transmitted to the caller for the subsequent conversation. This menu item functions independently of the system settings.

**7 Transmit number:** Your call number is transmitted to the caller for the subsequent (external or internal) conversation. This menu item functions independently of the system settings.

**8 LCR off:** Switches off LCR.

**9 Booking number:** You can use a booking number to record the call data from a telephone call with an external subscriber and save this data for further analysis in the Forum 500 / Forum 5000. Booking numbers can be useful for an office wanting to, for example, calculate the costs (fees accruing and time spent) of conversations with clients. Select this function from the menu. Enter the booking number under **No.** (max. 8 characters) and press  to confirm.

**O Remote dialling...:** You can also conduct a dialout for another terminal. Enter the **Device-ID:** of the terminal from which the dialling is to be conducted. Enter the call number to be called under **Dest.:**. You may also select the desired call number under the **Phone book** menu entry. Select the **On** option to save the dialout. The next time the subscriber whose device ID you entered picks up the handset, (or when using a headset, presses the headset key), the saved destination call number will be dialled automatically. This programmed number remains saved for 30 seconds. After 30 seconds, the dialout will be deactivated automatically. To manually deactivate the dialout beforehand, use the **Off** option.

**Tip:** The destination call number you select for the dialout can also be a call number saved in the phone book or is entered on a call list (re-dial list, missed calls list, call list of accepted calls and voicebox messages). To do so, save the **O Remote dialling...** feature to a function key (please refer to *Programming Functions (Features)* starting on page 138 also). When programming, enter the device ID of the other terminal but **not** the destination call number. You can now initiate a respective dial-out for this terminal by first selecting a call number from one of the lists or from the phone book and then press the function key. You can, of course, enter other destination call numbers. To do so, first press

the function key and then enter the desired call number under **Dest.:**

Select **3 Not available**, followed by ...

- 1 Callback:** This leaves a callback request with another subscriber whose line is busy to call you back (not possible with hunt group numbers).
- 2 VIP call....:** Your call is acoustically signalled, even if the person whose internal number you are calling has switched on call waiting protection, call protection or call forwarding.

Select **4 Call**, followed by ...

- 1 Toggle:** This toggles between current and previous callers.
- 2 Transfer:** This connects the caller on hold with the current caller.
- 3 Conference:** This initiates a three-way conference.
- 4 Mute:** This switches the microphone in the handset or in the telephone **On/Off**.
- 5 Hold:** Hold is a team function. The caller is put on hold and can now be transferred to another member of the team (see also the section on *Holding and transferring calls with a feature key* starting on page 101).
- 6 Intercept:** The numbers of malicious callers can be saved in the network operator's exchange (if they offer this service). The function can also be used also if the caller has already hung up!
- 7 Reject:** This rejects the call (this can also be an announcement), and the caller hears the busy tone.
- 8 Deflect call:** You do not accept the call. You specify the call number of another subscriber with **Destination**, and forward the call there after pressing . You can only use the "Deflect call" function if your user group is authorised to forward calls to internal and/or external destinations.
- 9 Park call:** You can "park" one or more callers while you make other calls (see *MenuCard "Conversation"* starting on page 63).
- 0 Call recording:** You start a call recording session. You will only see this menu entry if the system administrator has enabled the

function “Call recording” for you (also see chapter *Call Recording* starting on page 82).

**5 ISP connection:** You can, with the requisite user group authorisation, configure your system telephone to display and edit connections to the Internet established via the Forum 500 / Forum 5000. To do this, first assign the **5 ISP connection** function to a feature key. The key’s LED will light up and remain illuminated for the duration of the Internet connection.

**1 Disconnect:** This disconnects the Forum 500 / Forum 5000’s current connection to the Internet, disconnecting all active users from the Internet simultaneously.

**2 Allowed:** This allows Internet connections to be made using Forum 500 / Forum 5000. Activate this function by pressing .

**3 Prohibited:** This prohibits Internet connections from being made using Forum 500 / Forum 5000. Activate this function by pressing .

**6 Switch. auth. (Switch authorisation):** You switch another terminal to a user group defined by the system administrator. Switching the user group means different authorisations, e. g. international dialling authorisation. The switch only applies to the next call made from this terminal. Please contact your system administrator for information on altered authorisations when switching the user group.

**No. (call number):** Enter the internal call number of the terminal whose authorisation is to be switched. Use **On/Off** to activate/deactivate the switch.

**Phone book:** You can find and select the desired call number in the communications system phone book (see page 87). Use **On/Off** to activate/deactivate the switch.

**Note:** When the terminal to be switched is currently in the call state, the authorisation switch is carried out after the call is completed. If the next call is not begun within 60 seconds, the authorisation switch expires automatically. At the end of the call, you receive – if configured this way – a brief message on your telephone regarding call duration and relevant charges incurred.

**7 PIN dialling:** For the next call, you are switching your telephone into one of the user groups defined by the system administrator. Switching the

user group means different authorisations (e. g. international dialling authorisation) and other features are possibly available (e. g. for charging and recording connection data of private calls). Please contact your system administrator for information on the designated application area for PIN dialling.

First you enter your internal call number under **No.** and then your user PIN under **PIN**. Then you can dial the desired call number.

**Note:** PIN dialling can be done from any terminal which belongs to a user group with this authorisation activated. The call numbers dialled using PIN dialling are not saved in any redial list, neither on the terminal used, nor on one's own terminal.

**8 Door call:** A list of the configured entrance intercom systems is displayed. Select the desired entry from the list. The entrance intercom is called.

## MenuCard “Phone Book”

In this menu card you can add, edit and delete entries in your personal telephone book. If your system administrator has assigned you (or the user group you belong to) the necessary authorisation, you can also edit the central telephone book and your company telephone book.

You will find more information about company telephone books in the “Mounting and Commissioning” (Forum 523, Forum 525/526, Forum 550/560, Forum 5004/5008/5012) resp. “Commissioning and Maintenance” (Forum 5500) guide in the chapter entitled “Multi-Company Variant” and in Forum 500 / Forum 5000's online help.

For each of your personal entries (i.e. **Name**) you can enter several call numbers (**Office**, **Mobile** and **Private**) and set one of them as the **default number**. This number will always be called automatically if no other number is selected before making a call.

An entry in your company telephone book is created in exactly the same way as an entry in your personal telephone book. It can then be used by all employees in your company.

You can also assign speed dialling numbers to each call number in the central telephone book (**Abbrev. no.**). The system offers you the next free speed-dialling number.

## Creating a new telephone book entry

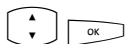

In the MenuCard **Phone book** select **1 New Entry** and press the OK key.

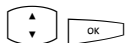

In the MenuCard **New Entry** select the required telephone book: **Personal**, **Central** or **Company**. Press the OK key to confirm.



Enter **Name** and **First name**. Press the OK key to confirm each entry.

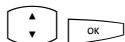

You can enter several call numbers for each entry (**Office**, **Mobile** and **Private**). Confirm each call number entry by pressing the OK key.

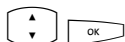

In the central telephone book you can assign a speed-dialling number (**Abbrev. no.**) to one or more call numbers of the telephone book entry. Select **Abbrev. no.** and press the OK key to confirm. In the MenuCard **Abbrev. no.**, select the **Office**, **Mobile** or **Private** call number and press the OK key to confirm. The system offers you the next free speed-dialling number. You can either accept this or specify another speed-dialling number which is still free. Repeat these steps to assign a speed-dialling number for another call number of the telephone book entry. You can exit entering speed-dialling numbers by selecting the **Ok** menu item in the **Abbrev. no.** MenuCard.

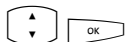

Afterwards select **Default** and press the OK key to confirm. In the MenuCard **Default**, select the **Office**, **Mobile** or **Private** call number as the default number and press the OK key to confirm.

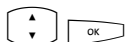

For each call number of the phone book entry, you can define whether or not your own call number is automatically transmitted if you call this call number. Select **Transmit number** and confirm with the OK key.

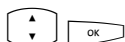

Select the call number in the **Transmit number** MenuCard (**Office**, **Mobile**, **Private**) and confirm with the OK key.



Select one of the following options and confirm the selection with the OK key:

- **Default:** You can decide before calling this call number whether or not your call number is to be transmitted or not (refer to the *MenuCard “Selection” in the Idle State* starting on page 57 chapter also).
- **yes:** Your call number is always displayed.
- **no:** Your call number is always suppressed.

If necessary, repeat the entry in order to configure the display of your own call number for another call number of the phone book entry. Terminate configuration by selecting the **Ok** menu entry in the **Transmit number** MenuCard.



To save the telephone book entry, select the **Save** menu item and press the OK key.

**Note:**

The option configured for transmitting your call number is only considered by the system if your user group has the **Display phone number per connection** authorisation activated. Contact your system administrator regarding your valid authorisation.

**Editing a telephone book entry**



In the **Phone book** MenuCard, select menu item **2 Edit** and press the OK key.



In the **Edit** MenuCard, select the desired telephone book: **Personal**, **Central** or **Company**. Press the OK key to confirm your selection.



Enter the name next to **Name** or (for **Central**) the speed-dialling number next to **Abbrev. no**. If there is no entry matching your search, the list of entries will be displayed. Select the desired entry. Press the OK key to confirm your selection.



Select **Delete** or **Edit**. To edit the telephone book entry, simply overwrite the current details. Proceed exactly as described above in the section *Creating a new telephone book entry* starting on page 131.

## MenuCard “Applications”

This MenuCard is only shown if the system administrator has set up additional programme packages for your communications system and you have the user authorisation to use these programmes.

- 1 Voicebox:** This menu is only available to you if the **Forum Voicemail** programme package has been installed in your communications system and if the system administrator has configured a voicebox for you. See the “Forum Voicemail” user guide for further information.
- 2 Hotel:** This menu is only available to you if the **Forum Hotel** programme package has been installed in your communications system and if your telephone is the receptions telephone. See the “Forum Hotel” user guide for further information.
- 3 Server menu:** Your communications system can also be extended via third-party programmes. It is possible to use individual functions of these programmes with your system telephone. The **3 Server menu** menu entry will be offered to you in this case. For further information, please consult the respective programme documentation.
- 4 ACD:** This menu is only offered if the **Forum ACD** internal application in your communications system is activated and if you are an agent of one or multiple ACD groups. If your system administrator has granted you the corresponding authorisations, you can operate this application via this menu. Refer to the “Forum ACD” guide for detailed information.

## MenuCard “Central Settings”

In this MenuCard you can define rules and settings for your system’s time management. You can only access this MenuCard if the system administrator has configured the required authorisations for your user group.



Select **O Central settings**, followed by ...

- 1 Time control:** Several time groups can be configured in the Forum 500 / Forum 5000. Incoming calls are then signalled on different telephones

depending on the activated time group. Switching between these time groups can be done automatically according to a timetable drawn up by the system administrator, or it can be done manually.

You can only programme these functions if the system administrator has activated the **Time control** authorisation for your user group.



Select the **Automatic** item to activate automatic time control. The configured time groups then change automatically according to the timetable configured by the system administrator. This setting remains active until one of the available time groups is set manually.

The system administrator can configure up to ten time groups. The time groups are either numbered (default setting) or named by the system administrator. You can select a specific time group manually, which deactivates the automatic time control.

**Note:** “MSN” forwarding always remains in effect, regardless of the currently active time group.

**2 Date/Time:** The date and time are taken from the exchange with the first external outgoing call. If your network operator does not transmit this information, you can set the date and time here yourself.

You can only program these functions if the system administrator has assigned the **Expert** service profile to your user group.

Select the required entry (time with **hh:mm**, date with **dd.mm.yy**) and press . Overwrite the current setting, confirm the new setting with  and **Save** your settings.

# Shortcut Menus

## MenuCard “Info”

This MenuCard is used to quickly locate messages that have arrived or been saved. The same menu items can also be found in the main menu. The LED flashes slowly to indicate that there are new entries in the info list.

**Briefly** press the info key  to display one or more of the following items ...

**1 Short messages:** See **Main menu**, menu group **3 Messages**

**2 E-Mail:** See **Main menu**, menu group **3 Messages**



**3 Missed calls:** See **Main menu**, menu group **1 Calls**

**4 Voicebox:** See **Main menu**, menu group **9 Applications**

**5 Appointments:** See **Main menu**, menu group **3 Messages**

**7 Charges:** See **Main menu**, menu group **1 Calls**

**8 Active features:** See the following MenuCard.

**9 Recordings:** See **Main menu**, menu group **1 Calls**



## MenuCard “Active Features”

This MenuCard gives you an overview of the active features that restrict your availability. The same menu items are also in the Main menu. You can deactivate features directly, thereby removing them from this MenuCard. The LED on the info key lights up to identify active features.

**Long press** the info key  to display one or more of the following items ...

**Call prot. all:** See **Main menu**, menu group **5 Protection**

**Divert all calls:** See **Main menu**, menu group **2 Call forwarding**

**Restricted dial:** Your telephone lock is activated. To unlock your telephone, press , enter your user PIN and press  to confirm. See also **Main menu**, menu group **5 Protection**

**Hunt group:** Hunt group numbers are configured for your telephone. You can activate or deactivate the signalling of hunt group calls. See the MenuCard **1 Calls**

**Time control:** You might not receive any external calls if the system’s mode of call forwarding has been changed. Contact your system administrator for further information. See the MenuCard **0 Central settings**

## MenuCard “Prog. call key”

This MenuCard can be used to quickly configure the features on a call key which has been programmed as a trunk key. For further information, please refer to the section on *MenuCard “Prog. call key” (Trunk Key)* starting on page 102.

## MenuCard “Prog. team key”

This MenuCard can be used to quickly configure the features of a call key which has been programmed as a team key. For further information, please refer to the section on *MenuCard “Prog. team key”* starting on page 104.

## Programming Keys

Your system telephone features several keys which you can individually configure with call numbers (destinations) or functions. You will find an overview of which keys on your telephone these are in the section on *Programmable Keys* starting on page 16. You can also connect up to three extra key extensions to your system telephone (exception: not to Forum Phone 515), which provides you with additional freely-programmable keys (see the chapter on *Key Extensions* starting on page 31).

**Note:** You can only programme programmable keys if your system administrator has provided you with the authorisation to do so. Consult your system administrator if your authorisation has to be changed.

You can also use the **Configurator** of the Web console (in the **Telephony > Devices > System Phones** menu) to assign destinations or functions to programmable keys. It doesn't matter whether the keys are programmed on the system telephone or in the **Configurator**. Settings are immediately valid and overwrite any previous settings in both cases.

## Programming Call Numbers (Destinations)

You can dial call numbers assigned to keys by simply pressing the relevant key.

### Programming a destination



**Long** press the programmable key, then ...





select **Dest.** and press the OK key.

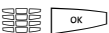

**Text:** Enter a name, then press the OK key.



**Dest.:** Enter the call number, then press the OK key.

- **External call number:** Enter the call number directly if external line seizure is automatic. If external line seizure is manual, you must first key in the external line seizure code digit (the default setting is ).
- **Internal call number:** Enter the call number directly if external line seizure is manual. If external line seizure is automatic, first press the star key twice  .

Please see the section on *Manual or Automatic Line Seizure* starting on page 58 for a more detailed explanation of automatic and manual line seizure.

You can also save a call number, that has been saved in the phone book, to a destination key. The first and last name of the phone book entry will automatically be included and the call number of the entry saved as destination call number.



Select the **Phone book** menu entry and then the desired entry. Then press the OK key.



If there are multiple call numbers saved to this entry, select the call number you would like to save to the destination key. Then press the OK key.



To end programming, select the **Save** menu item. Then press the OK key. The programming is saved.

## Changing destination key



To change or delete a destination key, **long** press the key, then ...



**Text: / Dest.:** Overwrite the programmed name / call number. Confirm each entry by pressing the OK key.



Select the **Save** menu item. Then press the OK key. The programming is saved.

## Deleting a programmed key



**Long** press the programmable key, then ...



select **Delete key**.



Press the OK key.

## Programming Functions (Features)

You can also store Main menu functions on programmable keys (see *Main Menu* starting on page 110). **Long** press the key and you will see the feature key's MenuCard with the name of the function in the first line (e. g. call forwarding). You can change the function as required (e. g. change the destination of the call forwarding).

**Note:** Some functions are displayed only, if the user group that is assigned to the telephone's user has the corresponding authorisations. Example: An "Intercom protection" feature key is programmable only, if the **Intercom protection** access right is granted for the user group.

### Switching functions on/off

The functions assigned to a key can be activated by a **short** press on the key or switched on and off by pressing the key (e. g. call forwarding). The function assigned to a key is active (switched on) when the key's LED lights up. If the programmed function conflicts with your terminal's current settings, a menu will open when you press the relevant feature key. You can use this menu to activate or deactivate the function again.

The following examples will help to explain this.

### Example 1 "forwarding MSN groups"

If you have assigned an MSN group to a feature key, the LED lights up if all MSNs in the group are forwarded to the destination number specified. If a single MSN is forwarded to a different number or not forwarded, the LED does not light up.

If you now press the feature key, a menu opens in which you can activate or deactivate the function again. The destination numbers for the individual MSNs of the group are overwritten and will have to be reprogrammed if required. Selecting **On** will forward all MSNs in the group to the originally programmed destination number, or you can specify a new destination

number. Selecting **Off** will deactivate all forwarding for all MSNs in the group.

### Example 2 “call waiting protection”

If you have assigned “Call waiting protection ” to a feature key, the LED lights up if call waiting protection is activated for all the call keys on your telephone. If you deactivate call waiting protection for a single call key (“Call waiting protection”), the LED goes out.

If you now press the feature key, a menu opens in which you can activate or deactivate the function. The call waiting protection for the single key is then deleted and will have to be reprogrammed if required.

With the **On** menu item you turn on call-waiting protection for all call keys. With the **Off** menu item you turn off call-waiting protection for all keys.

### Programming a function onto a key



**Long** press the programmable key, then ...



select **Features** and press the OK key.



Select the desired function from the MenuCards, specify the variable part (e. g. call number) if required, then press the OK key.



Select **Text**: to label the key. If you do not enter a text, the key will be labelled with a default text. Press the OK key.



The **Save** menu item is now selected. Press the OK key. The programming is saved.

You can also combine multiple functions on a single key. For more information on this please see the section on *Stacking or Linking Functions* starting on page 140.

### Changing a programmed feature key



**Long** press the programmed key, then ...

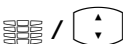

change the programmed function (e. g. the call number of a call forwarding) or select another function.



Confirm by pressing the OK key.



The **Save** menu item is now selected. Press the OK key. The programming is saved.

### Deleting a programmed feature key



**Long** press the programmed key, then ...



select **Delete key**.



Press the OK key.

## Stacking or Linking Functions

You can also save multiple functions to a single feature key (stack or link functions).

- **Stack:** The functions stored in a stack are displayed in a MenuCard which is assigned to a key. You can save destination numbers as well as functions in a stack and select the desired destination number or function from this MenuCard.
- **Link:** Linked functions are executed consecutively after the relevant key is pressed. This makes it possible to combine complex system telephone settings on a *single* feature key. You can programme more functions in a link than you can on a single feature key. A concrete setting for a function can be saved in a link (e.g on/off for “call protection” or a concrete display language). This means that a function in a link has an exactly defined switching function in comparison with the functioning of a single feature key.

A stack and a link have five free memory locations each.

### Programming multiple functions and/or call numbers on a key



**Long** press the programmable key, then ...



select **Stack** or **Link features** and press the OK key.

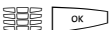

Select **Text:** to label the key. If you do not enter a text, the key will be labelled with the default text (either “Stack” or “Link”). Press the OK key.



Select **Add** and make a selection from the MenuCard shown ...

- **Features** to programme a feature key (see *Programming Functions (Features)* starting on page 138),
- **Dest.** to programme a destination key (see *Programming Call Numbers (Destinations)* starting on page 136); only possible when programming a stack.

Then press the OK key.

The MenuCard “Stack” or “Link” is shown with the new entry in the list. You can now add another entry. When all memory locations are occupied you will hear a negative acknowledgement tone.



To end programming, select the **Save** menu item. Then press the OK key. The programming is saved.

### Using a feature key (stack / link)

The LED of a key programmed as a stack has no function. You can use a key programmed as a **Stack** as follows:

- **Short key press:** The programmed entries are displayed in a selection menu. Select the desired entry and press the OK key . The programmed call number will be dialled or the programmed function executed.
- **Long key press:** The MenuCard for the key will be opened. You can now edit the stack's entries.

The illuminated LED of a key programmed as a link indicates that all functions of the link are active (switched on). You can use a key programmed as a **Link** as follows:

- **Short key press:** The programmed functions are executed consecutively. When all functions have been executed correctly, you will hear a positive acknowledgement tone.
- **Long key press:** The key's MenuCard will open. You can now edit the link's functions.

### Changing entries in a stack / link

You can change or delete individual entries in a stack or a link without deleting all the programming on the key.



**Long** press the programmed key, then ...



select the desired entry. To change the entry, press the OK key.



Select another function or change the programmed call number (for a destination key). To delete the entry, press the  key.



Press the OK key to save your programming.

### Deleting a programmed feature key (stack / link)



**Long** press the programmed key, then ...



select **Delete** key.



Press the OK key.

## Status Key

If your communications system has been extended via a third-party programme, you can operate individual functions of this programme via what are referred to as the status keys of your system telephone. A status key is thus a kind of special function key. It is programmed similarly to a function key.

### Programming a status key



**Long** press the programmable key, then ...



select **Status** key and press the OK key.



Select the **Key-ID**: item from the **Status** key MenuCard. Enter the number (0 ... 9) to be used for operating the programme function. For information in this regard, please refer to the respective programme documentation. Then press the OK key.





Select **Text**: to label the key. If you do not enter a text, the key will be labelled with a default text. Press the OK key.



The **Save** menu item is now selected. Press the OK key. The programming is saved.

## Deleting a programmed status key



**Long** press the programmed key, then ...



select **Delete key**.



Press the OK key.

# Busy Keys

Busy keys are function keys as well. A busy key shows you the busy state of another internal subscriber. There are two kinds of busy keys:

- **Busy Key “Call Number”**: This busy key shows the busy status of a single internal call number. This can be an internal call number of your own communications system or a call number of a system which can be reached via the telecommunications system network.

A “Call Number” busy key can either be programmed on the terminal or on the web console of the Forum 500 / Forum 5000 communications system (in the **Telephony > Devices > System phones** menu).

- **Busy Key “Device”**: This busy key monitors all trunk keys configured on a terminal. If one of these trunk keys is busy, the busy key signals that the terminal is busy.

A “Device” busy key can only be programmed on the web console of the Forum 500 / Forum 5000 communications system (in the **Telephony > Devices > System phones** menu).

## Notes for the system administrator

- A user must have the **Program busy keys** authorisation for programming a busy key on the terminal. This authorisation is configured in the **User manager > User groups** menu.

- Users cannot prevent authorised users from monitoring their call numbers via busy keys on their terminals.
- Programming busy keys on the web console is either done by the system administrator or by a user with the **Change** or **Change-Personal** authorisation for the **Telephony > Devices > System phones** menu. These authorisations are configured in the **User manager > Service profiles** menu.
- For further information on busy keys and PBX networking, please refer to the online help and in the “Mounting and Commissioning” guide (Forum 523/524, Forum 525/526, Forum 550/560, Forum 5004/5008/5012) or “Commissioning and Maintenance” guide (Forum 5500).

## Programming the “Call number” Busy Key on the Terminal



Press the programmable key for a **long** time.

The **Prog. feat. key** MenuCard is displayed.



Select **Prog. busy key**, press OK key.

The **Prog. busy key** MenuCard is displayed.

### Selecting subscriber from phone book



Select **Phone book**

When you press the  key now, the complete list of phone book entries saved on the communications system is displayed. The list is sorted alphabetically and you can page to the desired entry.



Alternatively: Enter the first few letters of the desired entry and press the  key.

The list of phone book entries located is displayed. All suitable search results are listed.



Use the arrow key to scroll through the list.

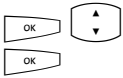

If an entry has multiple call numbers, you may directly select one of them. Press the OK key and select **Office**, **Mobile** or **Private**. Confirm your selection with the OK key.



*Alternative: Enter monitored call number*



**Text:** Label the key. If do not enter any text, the key is labelled with the call number.



**No.:** Enter the internal call number to be monitored.

Enter the call number directly if external line seizure is manual. If external line seizure is automatic, first press the star key twice  .

Please see the section on *Manual or Automatic Line Seizure* starting on page 58 for a more detailed explanation of automatic and manual line seizure.

*Option: Configuring acoustic signalling*

When the call number programmed is called, this can be signalled acoustically on the system telephone where the busy key has been programmed.



Select **Off**, press OK key.



Select one of the following options and confirm the selection with the OK key:

- **Off:** no ringing tone
- **normal:** one-time ringing tone
- **periodic:** periodic ringing tone

*Saving programming*



Select the **Save** menu item. Press the OK key.

The programming is saved.

## Using the Busy Key “Call Number”

### Busy display

The busy status of a monitored call number is signalled as follows:

- LED blinks: The call number is called.
- LED lights up: The call number is busy.

### Calling subscribers via the busy key



(LED off)

Press – when the call number is not busy, the LED is off – the busy key. The internal subscriber whose call number is assigned to the busy key, is called.

### Call pick-up via the busy key (pick-up)

The busy key LED **blinks** when there is an incoming call. To accept the call:

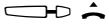

(LED off)

Press the busy key and pick up the handset. This means the call number called remains available.

### Transferring accepted call

The accepted call can be transferred to the originally called subscriber via the busy key.



(LED blinks)

Press the busy key. The caller is held.



(LED lights up)

If the subscriber answers, announce transfer of the call, and replace the handset. The call has now been transferred.

alternatively:



(LED blinks)

If you wish to transfer the call without announcement, replace the handset. The subscriber is called.

If the subscriber called does not accept the transferred call within a certain time interval (45 seconds are the default), you will be called back (the display shows callback information).

## Using the Busy Key “Device”

### Busy display

The busy key LED lights up on your telephone if one of the trunk keys on the monitored device is busy. If the monitored device is idle, this is not signalled by the busy key.

### Calling subscribers via the busy key



(LED off)

Press – when the terminal is not busy, the LED is off – the busy key. The internal subscriber is called on one of the available trunk keys.

**Note:** A “Device” busy key cannot be used to pick up or transfer accepted calls.

# Appendix

## Environmental Information

- The equipment that you bought has required the extraction and use of natural resources for its production. It may contain hazardous substances for the health and the environment.
- In order to avoid the dissemination of those substances in our environment and to diminish the pressure on the natural resources, we encourage you to use the appropriate take-back systems. Those systems will reuse or recycle most of the materials of your end life equipment in a sound way.
- The crossed-bin symbol invites you to use those systems.
- If you need more information on the collection, reuse and recycling systems, please contact your local or regional waste administration.
- You can also contact us for more information on the environmental performances of our products.



# Tones and Ringer Signals

Time axis in seconds

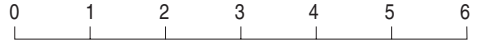

## Audio Signals

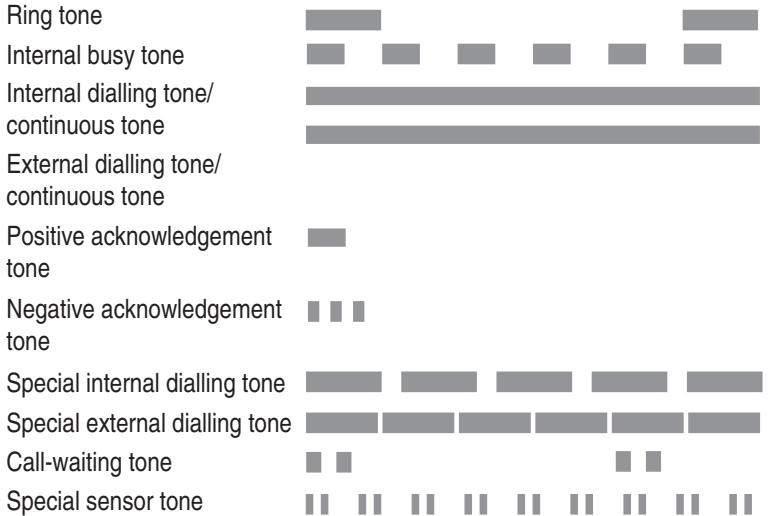

## Calls



The tones and ringer signals mentioned above are valid for Belgium; in other countries they may differ.

# Index

## A

- ABC key 17
- AC adapter plug 8
- ACD 133
- Announcement 57, 75, 126
- Announcement protection 103, 123
- Appointment call 75
- Appointments 120
- Arrow key 20
- Auto call answering 116
- Automatic call recording, see call recording 84
- Automatic dialling
  - for a different terminal 50
  - switching on/off 122
  - using 49
- Availability 124

## B

- Baby call 75, 124
- Block dialling
  - switching on/off 122
  - using 49
- Booking number 63, 127
- Busy key
  - call number 146
  - device 147
  - programming 144
- Busy keys 143

## C

- Call 128
  - accepting 67
  - accepting via busy key 146
  - connecting automatically 68
  - deflecting 70

- ending 63
  - pick up 125
  - recording 65, 82, 114, 128
  - rejecting 70
  - transferring to external party 72
  - transferring to internal party 71
- Call distribution 47
- Call diversion (see call forwarding) 102
- Call forwarding 117
  - all 135
  - door 118
  - door call 87
  - Follow me 119
  - for other users 119
  - MSN 117
  - remote-programmable 107
  - to voicebox 78
- Call key 47
- Call lists 112
- Call number
  - Forum Voicemail 108
  - suppress 58, 127
  - transmit 58, 127
- Call numbers
  - blocked 53
  - external 47
  - internal 47
  - transmission 55
  - unblocked 53
- Call protection 18, 103, 104, 123
  - all 135
- Call recording 84
- Call signalling 103, 104
- Call waiting
  - accepting 69, 70



- deflecting 70
- rejecting 70
- Call waiting protection 124
- Callback 66, 72, 128, 146
  - answering 78
- Caller history 80
- Calling
  - external calls 59
  - internal calls 60
  - using destination keys 61
  - via busy key 146, 147
- Call-waiting protection 103, 104
- Changing user PIN 124
- Charges 57, 103, 115
  - display 51
  - settings 122
- C-key 17
- Cleaning 9
- CLIP 55
- CLIP no screening 55, 68
- CLIR 56
- CNIP 55
- Comfort hunt group 116
- Conference 71, 73, 128
  - ending 74
- Contrast setting 122

## D

- Date 134
- Deflect call 128
- Deleting lists 29
- Device busy 117
- Dialling 126
  - for another terminal 127
  - restricted 135
- Digits
  - deleting 28
  - entering 28
- Direct call key 104

- Disconnect
  - external subscriber 74
  - internal subscriber 74
- Disconnect key 19
- Display 122
- Door call 130
- Door opener 57, 65, 70, 73, 74, 85, 126
- Doorbell 85, 87
- Doorphone 86
- DTMF 54
- Duration display 51

## E

- E-Mail 120
- Enquiry 71
- Enquiry key 19
- Entrance intercom 86
- Entrance intercom calls 86
- ESC key 20

## F

- Feature keys 138
  - linking 140
  - stacking 140

## H

- Hands-free mode 53
- Hands-free/open-listening key 18
- Headset 33, 95, 122
  - block dialling and headset operation 50
  - calling an external subscriber 59
  - calling an internal subscriber 60
  - ending call 63
  - listen in 19
- Headset key 19
- Hold 65, 128
- Hot Desking 92

Hotel 133  
Hunt group 115, 135

## I

Inclination (adjusting) 10  
Info key 18  
Info line(s) 23  
Installation site 9  
Intercept 65, 128  
Intercom 57, 126  
Intercom protection 125  
Internet connection (ISP) 129  
IP system telephones 95  
ISP trigger call 109

## K

Key assignments 12  
Key extensions 31  
Key lines 24  
Keypad 15  
Keypad dialling 54  
Keypad protocol 54  
Keys  
    deleting 124  
    labelling 21  
    programming 136

## L

Language setting 122  
Least Cost Routing (LCR) 54  
    switching off 58, 127  
Line seizure 58  
    automatic 58  
    manual 58  
Link (feature keys) 140  
Listen in (see headset) 19  
Logout (Hot Desking) 125

## M

Main menu 58  
    Applications 111  
    Call forwarding 111  
    Calls 111  
    Central settings 111  
    Connections 111  
    Messages 111  
    Phone book 111  
    Phone settings 111  
    Protection 111  
MenuCard  
    Active features 135  
    Applications 133  
    Busy 66  
    Call 70  
    Call forwarding 117  
    Call waiting 70  
    Calls 112  
    Central settings 133  
    Conference 74  
    Connections 125  
    Conversation 63  
    Info 134  
    Main menu 110  
    Messages 119  
    Phone book 88, 130  
    Phone settings 121  
    Prog. call key 102, 135  
    Prog. team key 104, 136  
    Protection 123  
    Selection (in idle state) 57  
    Subscr (Subscriber) on hold 73  
MenuCard display 26  
MenuCard key 17  
MenuCards  
    closing 30  
    invoking 26  
Messages 119

Muting 51, 128

Muting key 19

## N

Not available 128

Note 58, 65, 126

## O

OK key 20

Open listening 53

## P

Parking calls 64, 73, 128

Pharmacy line 87

Phone book 63, 87, 126

edit entry 132

new entry 131

Pick-up 57, 64, 125

message 122

on busy key 146

selective 57, 64, 66, 125

PIN (see user PIN) 124

PIN dialling 129

Plus/minus key 19

Presence 120

Programmable keys 136

destination 136

features 138

Programming destination 136

## R

Redial key 17

Redialling 51

Rejecting call 128

Remote charges 115

Remote-controlled dialling 105

Repair 8

Ring tone 103, 104, 121

incoming call types 121

key 121

message 122

## S

Safety precautions 8

Selecting list items 26

Server menu 133

Setting windows 28

Speed-dialling 89

Stack (feature keys) 140

Status key 142

Substitution 102

Switch authorisation 129

## T

Take 57, 64, 126

Team key (lists) 104

Tele secretary 67

Telephone lock 53, 124

Text

entering 29

modifying 102, 104

Three-party conference 73

Time 134

Time control 133, 135

Time groups 133

Toggling 28, 71, 73, 74, 128

Transfer 73, 74, 128

Transferring 71, 146

Trunk key 15

lists 104

## U

Unparking call 57, 126

---

## V

VF signalling 54

VIP call 66, 128

    accepting 67, 69

    starting 58

Voice over IP 95

Voicebox 133

    querying 70

    remote query 108

Voicemail system 78

Volume 51, 121

## W

Wall mounting 11

# Notes

# Notes

# Support

You can contact our support on the following telephone numbers:

## For configuration changes of your Forum™ 500 or Forum™ 5000 communications system

	SMEs and residential customers	Large companies
in Dutch:	0800 22 500	0800 22 200
in French:	0800 33 500	0800 33 200
in German:	0800 44 500	0800 44 200
in English:	0800 55 500	0800 55 200

## For repairs

	SMEs and residential customers	Large companies
in Dutch:	0800 22 500	0800 14 888
in French:	0800 33 500	0800 14 888
in German:	0800 44 500	0800 14 888
in English:	0800 55 500	0800 14 888

**For more information:**

- Visit us in the Internet at [www.proximus.be/pabx](http://www.proximus.be/pabx)
- Contact your Proximus dealer