

# Alcatel-Lucent 8125 Audiooffice

## User guide

R100

8AL90051USAAed02



• IMPORTANT INFORMATION	3
• SAFETY GUIDELINES	3
<b>1. DISCOVER YOUR ALCATEL-LUCENT 8125 AUDIOFFICE DOCK</b>	<b>4</b>
• BOX CONTENT	4
• YOUR ALCATEL-LUCENT 8125 AUDIOFFICE	4
<b>2. SET-UP</b>	<b>5</b>
• CONNECT YOUR DEVICES	7
• CONNECT A USB HANDSET (OPTIONAL)	7
<b>3. BLUETOOTH</b>	<b>7</b>
• BLUETOOTH 1ST CONNECTION	7
• MULTIPLE CONNECTIONS: PAIRING A NEW DEVICE / RECONNECT A DEVICE	8
• DISCONNECT A PAIRED DEVICE	8
• UNPAIR ALL THE CONNECTED DEVICES	8
<b>4. USE</b>	<b>8</b>
• PLACING OR RECEIVING AN ALCATEL-LUCENT DESKPHONE CALL IN JACK MODE	8
• PLACING OR RECEIVING AN ALCATEL-LUCENT DESKPHONE CALL IN BLUETOOTH MODE	8
• PLACING OR RECEIVING A MOBILE CALL	9
• RECEIVING AND ENDING A VOIP CALL ON YOUR MOBILE	9
• ADJUSTING THE VOLUME	9
• ACTIVATING AND DESACTIVATING THE MUTE	9
• ACTIVATING AND DESACTIVATING THE SPEAKERS	9
• LISTENING TO MUSIC	9
• OPTIONAL USB HANDSET	9
• UPDATING YOUR ALCATEL-LUCENT 8125 AUDIOFFICE	10
• AUDIOFFICE APP SETTINGS	10
<b>5. TECHNICAL DATA</b>	<b>11</b>
• MFI PROGRAM	11
• ALCATEL-LUCENT DESKPHONES COMPATIBILITY	11
• CONNECTIVITY	11
• TECHNICAL SPECIFICATIONS	11
• BUTTONS	11
<b>6. WARRANTY</b>	<b>12</b>
<b>7. SUPPORT</b>	<b>12</b>
<b>8. ANNEX</b>	<b>12</b>
• INSTALLING AUDIOFFICE OPTIONAL USB HANDSET	12
• USING AUDIOFFICE OPTIONAL USB HANDSET	13
<b>9. SAFETY AND REGULATORY INSTRUCTIONS</b>	<b>14</b>
• DECLARATION OF CONFORMITY FOR THE EUROPEAN UNION	14
• U.S. FEDERAL COMMUNICATIONS COMMISSION (FCC) COMPLIANCE STATEMENT	14
• ENVIRONMENT	14
• LEGAL	14

## Important information

### Safety Guidelines

#### Required Power Supply

This dock is powered through a mains AC 100-240V supply.

#### Warning

- Do not open the base or charger.
- Please ensure that no liquid comes into contact with the product.  
Do not expose the device to excessive smoke, dust, mechanical vibration or shock.
- Only use the cables, adapters and batteries supplied.
- Place the unit near an accessible electrical outlet.
- Do not expose the device to excessive heat, e.g. to direct sunlight or near heating equipment.
- Do not use in areas where there are risks of explosion.

#### Operating and storage temperature

Use the device in a room where the temperature is always between 0 and 40°C (32 to 104°F).

# 1. Discover your Alcatel-Lucent 8125 Audiooffice dock

## Box content

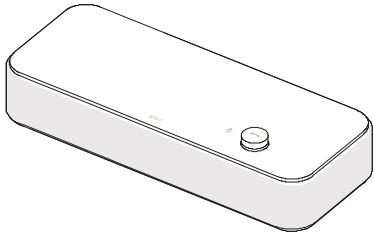

Alcatel-Lucent 8125 Audiooffice base

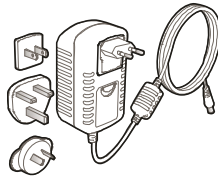

AC adapter

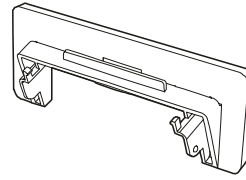

Tablet holder

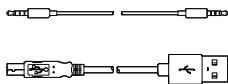

Jack 3.5 mm cable  
USB type A - type B cable

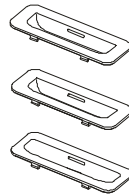

Lightning, 30 pin and micro-USB adapters

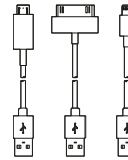

Lightning, 30 pin and micro-USB cables

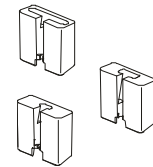

Lightning, 30 pin and micro-USB cable adapters

## Your Alcatel-Lucent 8125 Audiooffice

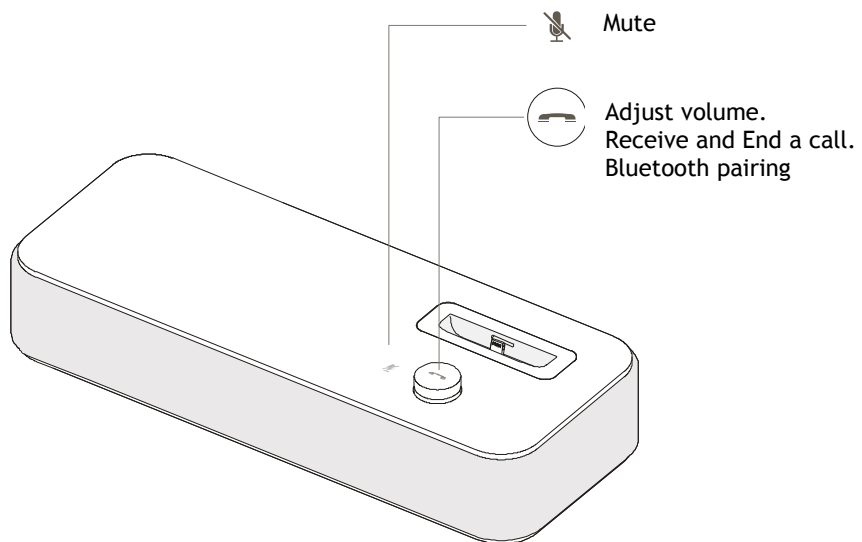

Designed and produced by invoxia, Paris

## 2. Set-up

Place your Alcatel-Lucent 8125 Audiooffice near your mains supply socket.

Once installed, to benefit from the best sound quality avoid placing any objects (walls or cumbersome objects) within a range of 20cm.

1. Install the tablet holder if necessary

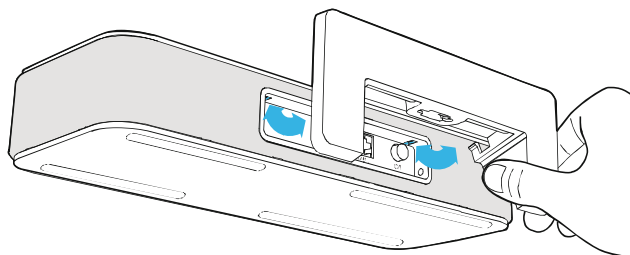

2. Insert the cable suitable to your smartphone into the matching cable adapter.

Place the cable in the cable hole.

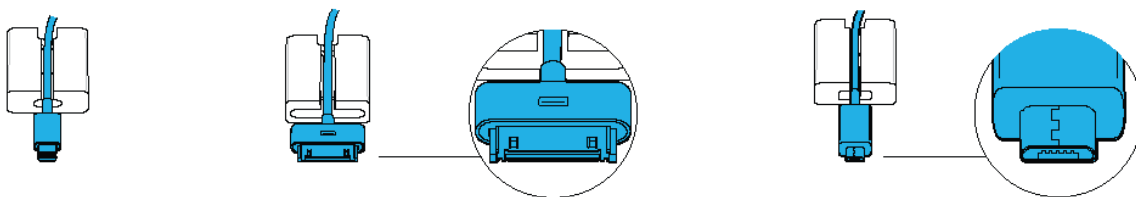

 Place the 30 pin cable with the 30 pin icon on top.

3. Slide the cord into place through the interstices under the base.

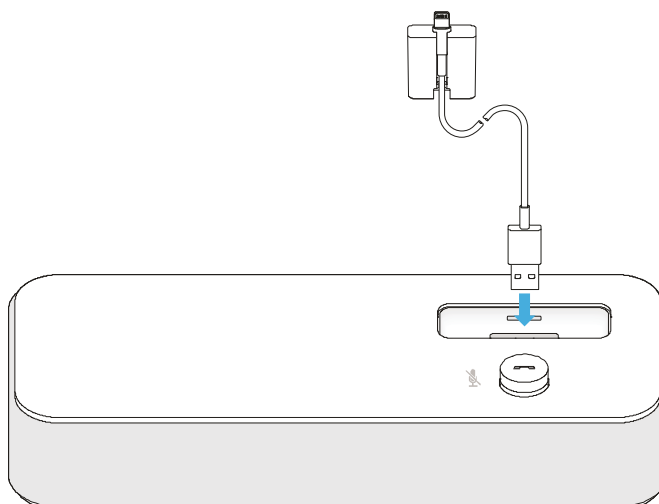

 Beware of the cable adapter direction while inserted.

- Slide the cord into place through the interstices under the base.

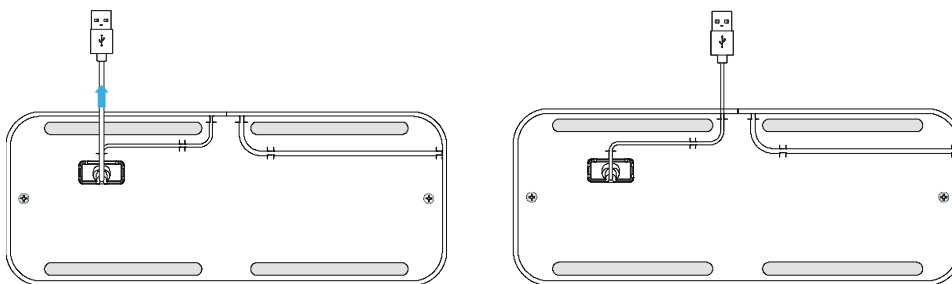

- Plug the USB connector to the left USB port at the rear of the device.

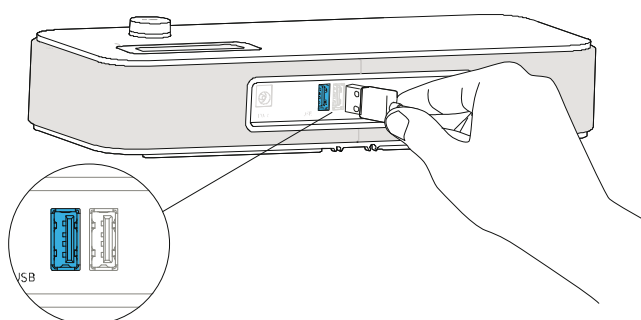

- Insert the suitable adapter to your smartphone, or none if you use a case and your device doesn't fit.  
To connect a different model, please repeat steps 2 to 6.

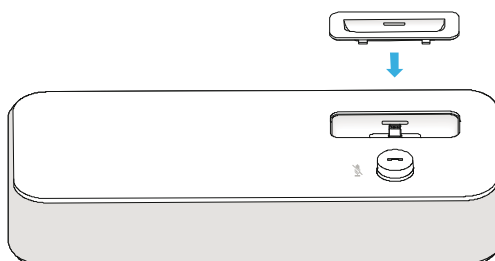

- Plug the mains power adapter into the back of the base and into a wall mount socket.

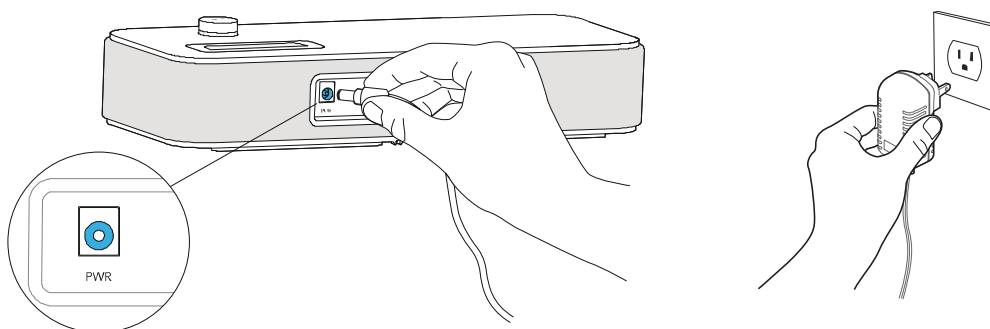

- Press the On / Off button at the back of the base.

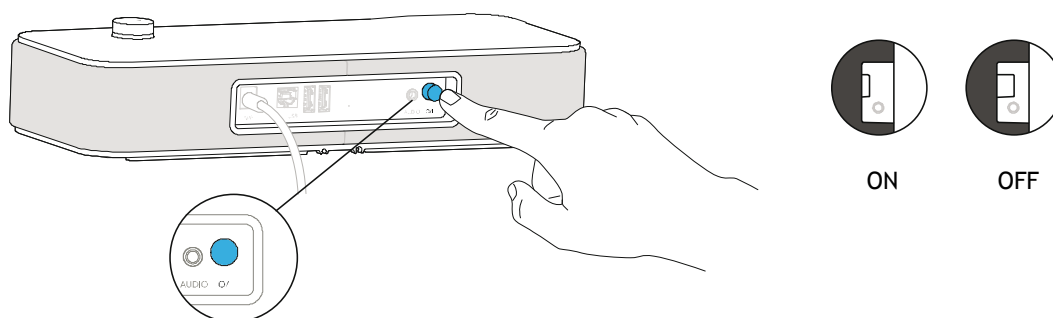

## Connect your devices

The USB slave port is to connect your computer to have the sound on the 8125, the two USB masters ports are there to allow you to charge other devices like smartphones and tablets.

The 3.5 mm jack allows you to connect your Alcatel-Lucent IP deskphone.

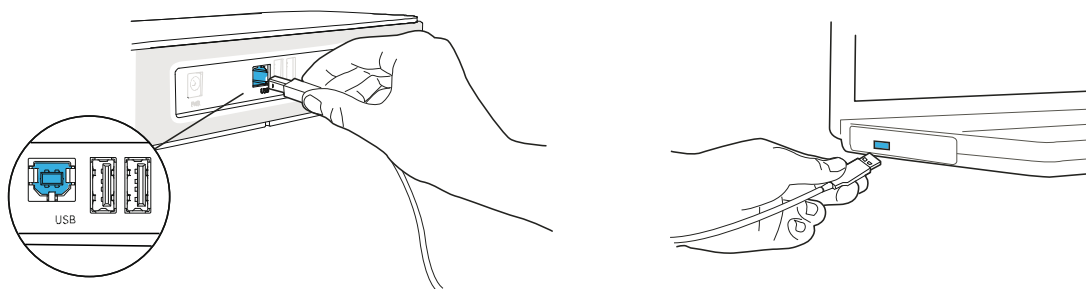

## Connect a USB handset (optional)

A USB handset (available in option) may be plugged to one of the two USB masters ports at the back of the base.

## 3. Bluetooth

The voice messages are in english until a first device is paired, the unit will then adopt the language of the Bluetooth device paired.

### Bluetooth 1st connection

With iOS 6, be sure your Bluetooth is activated first

- For Alcatel-Lucent Bluetooth deskphones, Android and iOS devices: long push the volume button until you hear a sound signal.  
A «Pairing mode: waiting for connection» message allows you to pair your Alcatel-Lucent 8125 Audiooffice in your device Bluetooth menu.  
A final sound confirms the pairing

## Multiple connections: Pairing a new device / Reconnect a device

With iOS 6, be sure your Bluetooth is activated first

- For Alcatel-Lucent Bluetooth deskphones, Android and iOS devices: long push the volume button until you hear a sound signal. A «Pairing mode: waiting for connection» message allows you to pair your Alcatel-Lucent 8125 Audiooffice in your device Bluetooth menu. Final sound confirms the pairing.
- Connecting a previously paired device is easy from its Bluetooth menu. The last connected device is the controlling device.

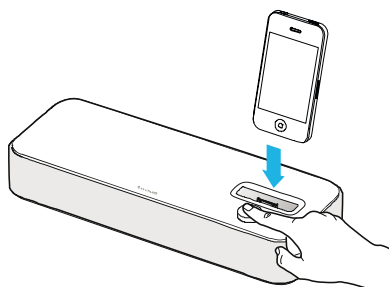

### Disconnect a paired device

- Long push the volume button until hearing a double-sound signal. The last connected device is then disconnected and auto-connection is stopped. A «Disconnecting» message and a sound signal confirm the disconnection.

### Unpair all the connected devices

- Long push the volume button until hearing a three-sound signal. A “Clearing all subscriptions” message confirms it.

 Also forget the Alcatel-Lucent 8125 Audiooffice from your device Bluetooth menu in order to complete future pairings between these devices.

## 4. Use

Use Alcatel-Lucent 8125 Audiooffice as a conference module for your Alcatel-Lucent Deskphone or for your Alcatel-Lucent Softphone on your mobile.

### Placing or receiving an Alcatel-Lucent Deskphone call in jack mode

Upon jack connection to the Alcatel-Lucent Deskphone, user needs to configure the jack interface to “External Handsfree” in order to use it for conference.

The jack connected, dial from your Alcatel-Lucent Deskphone and press the Alcatel-Lucent 8125 Audiooffice volume button to use it as a conference device.

To end the call, hang up the call from the phone.

Muting a call can be done with the Audiooffice Mute button or thru the Alcatel-Lucent Deskphone Mute key.

### Placing or receiving an Alcatel-Lucent Deskphone call in Bluetooth mode

Add the Alcatel-Lucent 8125 Audiooffice in the Alcatel-Lucent Deskphone Bluetooth device list with entering 0000 as a pin code.

Dial from your Alcatel-Lucent Deskphone and press the Alcatel-Lucent 8125 Audiooffice volume button to use it as a conference device.

To end the call, you can press the volume button again or hang up the call from the phone.

Muting a call can be done with the Audiooffice Mute button or thru the Alcatel-Lucent Deskphone Mute key.



## Placing or receiving a mobile call

A Bluetooth connection is needed to place and receive your mobile calls on the Alcatel-Lucent 8125 Audiooffice. To place a mobile call:

1. Dial from your mobile, or select your contact on your Contact list.
2. Choose Alcatel-Lucent 8125 Audiooffice as an audio output. You may also push the base volume button to have the sound on the device.

To receive a mobile call:

1. Pick-up the USB handset (optional).
2. From your smartphone and the Answer button. Choose the Alcatel-Lucent 8125 Audiooffice as audio output to have the call on the Alcatel-Lucent 8125 Audiooffice speakerphone.
3. From the base, press the volume button. The incoming call is then received in speaker mode.

Press Alcatel-Lucent 8125 Audiooffice button to receive and to end a call in handsfree mode.

## Receiving and ending a voip call on your mobile

A Bluetooth connection is needed to place and receive your mobile calls on the Alcatel-Lucent 8125 Audiooffice. To receive and end a voip call, use your Alcatel Lucent softphone application.

NB: The volume button can't be used as a pick-up / hang-up direct solution in this configuration.

## Adjusting the volume

Turn the volume button to regulate the volume coming from the speakers.

## Activating and deactivating the mute

Tap the Mute icon from your Alcatel-Lucent deskphone or directly from the Alcatel-Lucent 8125 Audiooffice icon.

## Activating and deactivating the speakers

To accept a call in speaker mode or to switch to speaker mode during a call, press the volume button on the base.

## Listening to music

Listening to your music from your smartphone and tablet is easy with a Bluetooth connection.

Apple users, you may also control your Music App by using the volume button:

- One tap on the volume button for Play / Pause
- A quick double tap on the volume button plays next song
- Quick triple tap on the volume button goes to previous song.

## Optional USB handset

You can order an optional USB handset shipped with a smart holder.

The optional USB handset allows to benefit from a clear sound for individual call and keep you away from mobile airwaves with a great listening comfort.

To answer a call, pick-up the handset, tap «Answer» from your smartphone when receiving incoming mobile and softphone app calls or press the volume button.

To end a call, hang-up the handset on the smart-holder, select «End» on your smartphone or tablet or press the volume button when in handsfree.

You can switch from handset to handsfree:

- In handsfree, to switch to the handset, just pick-it-up.
- With the handset, press the volume button to switch in handsfree.

Beware: in handsfree if you press the volume button, you'll hang-up the call, you won't switch to the handset.

## Updating your Alcatel-Lucent 8125 Audiooffice

To always benefit from the last features and acoustics improvements made to the Alcatel-Lucent 8125 Audiooffice, we regularly updates the device firmware.

You have two solutions:

1. With a USB Stick:

Follow this link [https://businessportal.alcatel-lucent.com/alugesdp/faces/gesdp/products/Listing.jspx?PRODUCT=AudiOffice\\_8115\\_8125&DOCTYPE=Software&BOXES=product%2Cdoctype&OPENFOLDER=product.AudiOffice\\_8115\\_8125](https://businessportal.alcatel-lucent.com/alugesdp/faces/gesdp/products/Listing.jspx?PRODUCT=AudiOffice_8115_8125&DOCTYPE=Software&BOXES=product%2Cdoctype&OPENFOLDER=product.AudiOffice_8115_8125) and go into the 8125-8115 section under "Phones".

Download the last available firmware version. Save it in root of the USB stick, then insert the USB key into your Audiooffice. The volume button led flashes during the update and is kept enlightened when the firmware is up-to-date.

You may then turn the base Off, remove the USB stick and turn the base On again.

2. With the Audiooffice application: free on the AppStore.

Dock or USB connect your smartphone / tablet to the Alcatel-Lucent 8125 Audiooffice.



When a new update is available, the Audiooffice app displays a “ New firmware version available” message on the Home screen. You can also go in the Audiooffice app under Settings > General > Check update.

It may take a few minutes. At the end of the update, the Audiooffice reboots, when over, it's ON and ready-for-use.

## Audiooffice app Settings

The Audiooffice app also lets you manage some features:

Go to Home > Settings

- Sound: volume of ringtone, alerts startup sound, etc  
You may choose your ringtone in Sounds > Ringtones and select the ringtone of your choice.  
You may choose the USB slave audio mode: choose “Music” to have the best sound quality for music listening with stereo playback, choose “Voice” to be able to use the microphones capture and mono playback.  
N.B.: When changing the mode, wait a few seconds before use.
- Bluetooth: to manage your Bluetooth settings, connections and your audio out settings.  
Please note that you may turn the “Call handling” feature ON to always have the sound on your Alcatel-Lucent 8125 Audiooffice. By turning it OFF, a simple push on the Alcatel-Lucent 8125 Audiooffice volume button will let you have the sound on the Alcatel-Lucent 8125 Audiooffice.  
This feature prevents you to receive your calls on the Alcatel-Lucent 8125 Audiooffice when you're still in a Bluetooth range of the device but not willing to have the sound on the Alcatel-Lucent 8125 Audiooffice.
- General - Application: details about your firmware and application for updates and debug information.

## 5. Technical Data

### Mfi program

Made for iPod, Made for iPhone, Made for iPad  
Compatible 4th and 3rd generation iPod Touch, iPhone 5S, 5C, 5, 4S, 4, 3GS, iPad mini, new iPad, iPad 2 and iPad  
Connection through USB to Lightning / 30 pin / micro-USB cables or Bluetooth  
Universal support for iPhone 5S, 5C, 5, iPhone 4S/4, 3GS et 3G and Samsung Galaxy SIII

### Alcatel-Lucent DeskPhones compatibility

Made for 8012, 4028/4029, 4038/4039, 4068 Alcatel-Lucent Deskphones  
8028/29, 8038/39, 8068, 8068BT Premium Deskphones  
8082 Smart Deskphone

### Connectivity

1 USB slave port  
2 USB port  
1 jack 3.5 mm input and output

### Technical Specifications

Power supply: 100-240V / 12V 3A AC adapter  
Dimensions: 29x11,5x5,25cm  
Operating temperature: 0°C - 40°C  
Weight: 0,9 kg  
Humidity: 10% - 90%

### Buttons

On/ Off button

 Volume / Answer button / Bluetooth connection

 Mute

## 6. Warranty

The standard Alcatel-Lucent Enterprise warranty will apply to the dock and not accessories. Details are available at <https://business.portal.alcatel-lucent.com> under the customer section category Hardware Support.

## 7. Support

e-Support from the Alcatel-Lucent Business Partners Web site : <https://businessportal.alcatel-lucent.com> click under "Let us help you" the eService Request link.  
e-mail: [Ebg\\_Global\\_Supportcenter@alcatel-lucent.com](mailto:Ebg_Global_Supportcenter@alcatel-lucent.com)

## 8. Annex

### Installing Audiooffice Optional USB Handset



1. Plug Handset cord into the right USB port at the back of the base.

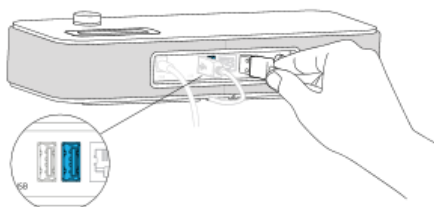

2. Place the Smart Holder and the Handset on the top of the base.

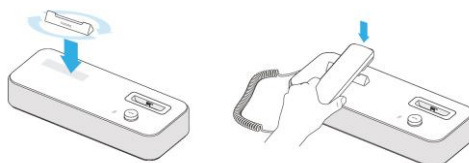

3. Press the On/Off button at the back of the base.

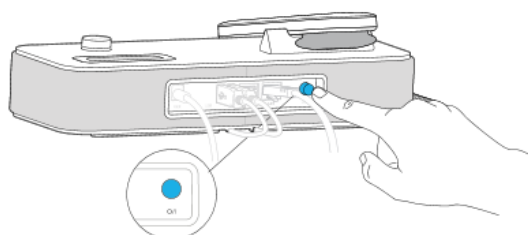

## Using Audiooffice Optional USB Handset

### Receiving a Mobile Call

1. Pick-up the handset from its base.
2. To accept a call in speaker mode or to switch to speaker mode during a call, press the volume button on the base.
3. In a speaker mode call when the handset is still picked-up, pushing the volume button will toggle between handset and speaker mode.

When the handset is on the smart holder, pushing the volume button will hang up the call.

### Ending a Mobile Call

1. By replacing the handset on the base.
2. In speaker mode, by pressing the volume button.

### Mobile or Personal Computer VoIP Call

1. Use your Mobile or Personal Computer VoIP Application to receive and end a VoIP call.
2. In a speaker mode call when the handset is still picked-up, pushing the volume button will toggle between handset and speaker mode.

The volume button and handset can't be used as a pick-up / hang-up direct solution in this configuration.

## 9. Safety and regulatory instructions

### Declaration of Conformity for the European Union

Invoxia declares that the Alcatel-Lucent 8125 Audiooffice product complies with the essential requirements and other relevant provisions of the European RTTE Directive 1999/5/EC on Radio and Telecommunication Terminal Equipment.



### U.S. Federal Communications Commission (FCC) Compliance Statement

This device complies with part 15 of the FCC Rules. Operation is subject to the following two conditions: (1) This device may not cause harmful interference, and (2) this device must accept any interference received, including interference that may cause undesired operation.

The changes or modifications not expressly approved by the party responsible for compliance could void the user's authority to operate the equipment.

To comply with the FCC RF exposure compliance requirements, this device and its antenna must not be co-located or operating to conjunction with any other antenna or transmitter.

Note: This equipment has been tested and found to comply with the limits for a Class B digital device, pursuant to part 15 of the FCC Rules.

These limits are designed to provide reasonable protection against harmful interference in a residential installation. This equipment generates, uses and can radiate radio frequency energy and, if not installed and used in accordance with the instructions, may cause harmful interference to radio communications. However, there is no guarantee that interference will not occur in a particular installation.

If this equipment does cause harmful interference to radio or television reception, which can be determined by turning the equipment off and on, the user is encouraged to try to correct the interference by one or more of the following measures:

- Reorient or relocate the receiving antenna.
- Increase the separation between the equipment and receiver.
- Connect the equipment into an outlet on a circuit different from that to which the receiver is connected
- Consult the dealer or an experienced radio/TV technician for help.

### Environment



Your Alcatel-Lucent 8125 Audiooffice dock has been designed and manufactured using quality materials and components which can be reused and recycled. The presence of the crossed-out wheeled bin symbol indicates that the product complies with EU Directive 2002/96/EC.

It must be disposed of through an appropriate collection and recycling structure.

Please contact your local electrical and electronic equipment waste management scheme.

Please respect your local municipal regulations and do not dispose of these products with unsorted household waste.

The correct disposal of products at the end of their working life is good for the environment and your health.

### Legal

Alcatel-Lucent, Alcatel-Lucent 8125 Audiooffice and related trademarks, names and logos are the property of Alcatel-Lucent.

Invoxia ®, Audiooffice™ are registered trademarks of Invoxia.